

## **OPC 10000-3**

# **OPC Unified Architecture Part 3: Address Space Model**

**Release 1.04**

**2017-11-22**



Specification Type:	Industry Standard Specification	Comments:	Report or view errata: <a href="http://www.opcfoundation.org/errata">http://www.opcfoundation.org/errata</a>
Document Number	<b>OPC 10000-3</b>		
Title:	OPC Unified Architecture  Part 3 :Address Space Model	Date:	2017-11-22
Version:	Release 1.04	Software:	MS-Word
		Source:	OPC 10000-3 - UA Specification Part 3 - Address Space Model 1.04.docx
Author:	OPC Foundation	Status:	Release

## CONTENTS

FIGURES .....	viii
TABLES .....	x
1 Scope .....	1
2 Normative references .....	1
3 Terms, definitions, abbreviations and conventions .....	2
3.1 Terms and definitions .....	2
3.2 Abbreviations .....	3
3.3 Conventions .....	3
3.3.1 Conventions for AddressSpace figures .....	3
3.3.2 Conventions for defining NodeClasses .....	4
4 AddressSpace concepts .....	5
4.1 Overview .....	5
4.2 Object Model .....	5
4.3 Node Model .....	5
4.3.1 General .....	5
4.3.2 NodeClasses .....	6
4.3.3 Attributes .....	6
4.3.4 References .....	6
4.4 Variables .....	7
4.4.1 General .....	7
4.4.2 Properties .....	7
4.4.3 DataVariables .....	7
4.5 TypeDefinitionNodes .....	8
4.5.1 General .....	8
4.5.2 Complex TypeDefinitionNodes and their InstanceDeclarations .....	8
4.5.3 Subtyping .....	9
4.5.4 Instantiation of complex TypeDefinitionNodes .....	9
4.6 Event Model .....	10
4.6.1 General .....	10
4.6.2 EventTypes .....	11
4.6.3 Event Categorization .....	11
4.7 Methods .....	12
4.8 Roles .....	12
4.8.1 Overview .....	12
4.8.2 Well Known Roles .....	12
4.8.3 Evaluating Permissions with Roles .....	13
5 Standard NodeClasses .....	15
5.1 Overview .....	15
5.2 Base NodeClass .....	15
5.2.1 General .....	15
5.2.2 NodeId .....	16
5.2.3 NodeClass .....	16
5.2.4 BrowseName .....	16
5.2.5 DisplayName .....	16
5.2.6 Description .....	16

5.2.7	WriteMask .....	16
5.2.8	UserWriteMask .....	17
5.2.9	RolePermissions .....	17
5.2.10	UserRolePermissions .....	18
5.2.11	AccessRestrictions .....	18
5.3	ReferenceType NodeClass .....	18
5.3.1	General .....	18
5.3.2	Attributes .....	19
5.3.3	References .....	20
5.4	View NodeClass .....	21
5.5	Objects .....	23
5.5.1	Object NodeClass .....	23
5.5.2	ObjectType NodeClass .....	25
5.5.3	Standard ObjectType FolderType .....	26
5.5.4	Client-side creation of Objects of an ObjectType .....	26
5.6	Variables .....	26
5.6.1	General .....	26
5.6.2	Variable NodeClass .....	27
5.6.3	Properties .....	30
5.6.4	DataVariable .....	30
5.6.5	VariableType NodeClass .....	31
5.6.6	Client-side creation of Variables of an VariableType .....	33
5.7	Method NodeClass .....	33
5.8	DataTypes .....	35
5.8.1	DataType Model .....	35
5.8.2	Encoding Rules for different kinds of DataTypes .....	36
5.8.3	DataType NodeClass .....	37
5.8.4	DataTypeEncoding and Encoding Information .....	39
5.9	Summary of Attributes of the NodeClasses .....	40
6	Type Model for ObjectTypes and VariableTypes .....	40
6.1	Overview .....	40
6.2	Definitions .....	40
6.2.1	InstanceDeclaration .....	40
6.2.2	Instances without ModellingRules .....	40
6.2.3	InstanceDeclarationHierarchy .....	41
6.2.4	Similar Node of InstanceDeclaration .....	41
6.2.5	BrowsePath .....	41
6.2.6	Attribute Handling of InstanceDeclarations .....	41
6.2.7	Attribute Handling of Variable and VariableTypes .....	41
6.2.8	NodeIds of InstanceDeclarations .....	41
6.3	Subtyping of ObjectTypes and VariableTypes .....	41
6.3.1	Overview .....	41
6.3.2	Attributes .....	42
6.3.3	InstanceDeclarations .....	42
6.4	Instances of ObjectTypes and VariableTypes .....	45
6.4.1	Overview .....	45
6.4.2	Creating an Instance .....	45
6.4.3	Constraints on an Instance .....	46
6.4.4	ModellingRules .....	46

- 6.5 Changing Type Definitions that are already used ..... 54
- 7 Standard ReferenceTypes..... 55
  - 7.1 General ..... 55
  - 7.2 References ReferenceType ..... 55
  - 7.3 HierarchicalReferences ReferenceType..... 55
  - 7.4 NonHierarchicalReferences ReferenceType ..... 56
  - 7.5 HasChild ReferenceType..... 56
  - 7.6 Aggregates ReferenceType ..... 56
  - 7.7 HasComponent ReferenceType ..... 56
  - 7.8 HasProperty ReferenceType ..... 57
  - 7.9 HasOrderedComponent ReferenceType ..... 57
  - 7.10 HasSubtype ReferenceType ..... 57
  - 7.11 Organizes ReferenceType ..... 57
  - 7.12 HasModellingRule ReferenceType..... 57
  - 7.13 HasTypeDefinition ReferenceType ..... 58
  - 7.14 HasEncoding ReferenceType ..... 58
  - 7.15 GeneratesEvent ..... 58
  - 7.16 AlwaysGeneratesEvent ..... 58
  - 7.17 HasEventSource ..... 58
  - 7.18 HasNotifier ..... 59
- 8 Standard DataTypes ..... 60
  - 8.1 General ..... 60
  - 8.2 NodeId ..... 60
    - 8.2.1 General ..... 60
    - 8.2.2 NamespaceIndex ..... 60
    - 8.2.3 IdentifierType ..... 61
    - 8.2.4 Identifier value ..... 61
  - 8.3 QualifiedName ..... 62
  - 8.4 LocaleId ..... 62
  - 8.5 LocalizedText ..... 62
  - 8.6 Argument ..... 63
  - 8.7 BaseDataType..... 63
  - 8.8 Boolean..... 63
  - 8.9 Byte ..... 63
  - 8.10 ByteString ..... 63
  - 8.11 DateTime ..... 63
  - 8.12 Double ..... 63
  - 8.13 Duration ..... 63
  - 8.14 Enumeration ..... 64
  - 8.15 Float..... 64
  - 8.16 Guid ..... 64
  - 8.17 SByte ..... 64
  - 8.18 IdType..... 64
  - 8.19 Image..... 64
  - 8.20 ImageBMP ..... 64
  - 8.21 ImageGIF ..... 64
  - 8.22 ImageJPG ..... 64
  - 8.23 ImagePNG ..... 64
  - 8.24 Integer ..... 64

8.25	Int16.....	64
8.26	Int32.....	64
8.27	Int64.....	65
8.28	TimeZoneDataType .....	65
8.29	NamingRuleType .....	65
8.30	NodeClass .....	65
8.31	Number .....	65
8.32	String .....	65
8.33	Structure .....	65
8.34	UInteger .....	65
8.35	UInt16 .....	66
8.36	UInt32 .....	66
8.37	UInt64 .....	66
8.38	UtcTime .....	66
8.39	XmlElement.....	66
8.40	EnumValueType .....	66
8.41	OptionSet.....	67
8.42	Union .....	67
8.43	DateString.....	67
8.44	DecimalString.....	67
8.45	DurationString .....	67
8.46	NormalizedString.....	68
8.47	TimeString.....	68
8.48	DataTypeDefinition.....	68
8.49	StructureDefinition .....	68
8.50	EnumDefinition .....	69
8.51	StructureField.....	69
8.52	EnumField .....	70
8.53	AudioDataType.....	70
8.54	Decimal.....	70
8.55	PermissionType.....	70
8.56	AccessRestrictionsType .....	71
8.57	AccessLevelType .....	71
8.58	AccessLevelExType .....	72
8.59	EventNotifierType.....	72
8.60	AttributeWriteMask .....	73
9	Standard EventTypes.....	73
9.1	General.....	73
9.2	BaseEventType .....	74
9.3	SystemEventType .....	74
9.4	ProgressEventType .....	74
9.5	AuditEventType .....	74
9.6	AuditSecurityEventType .....	76
9.7	AuditChannelEventType .....	76
9.8	AuditOpenSecureChannelEventType .....	76
9.9	AuditSessionEventType.....	76
9.10	AuditCreateSessionEventType .....	76
9.11	AuditUrlMismatchEventType.....	76
9.12	AuditActivateSessionEventType .....	77

- 9.13 AuditCancelEventType ..... 77
- 9.14 AuditCertificateEventType ..... 77
- 9.15 AuditCertificateDataMismatchEventType ..... 77
- 9.16 AuditCertificateExpiredEventType ..... 77
- 9.17 AuditCertificateInvalidEventType ..... 77
- 9.18 AuditCertificateUntrustedEventType ..... 77
- 9.19 AuditCertificateRevokedEventType ..... 77
- 9.20 AuditCertificateMismatchEventType ..... 77
- 9.21 AuditNodeManagementEventType ..... 77
- 9.22 AuditAddNodesEventType ..... 77
- 9.23 AuditDeleteNodesEventType ..... 78
- 9.24 AuditAddReferencesEventType ..... 78
- 9.25 AuditDeleteReferencesEventType ..... 78
- 9.26 AuditUpdateEventType ..... 78
- 9.27 AuditWriteUpdateEventType ..... 78
- 9.28 AuditHistoryUpdateEventType ..... 78
- 9.29 AuditUpdateMethodEventType ..... 78
- 9.30 DeviceFailureEventType ..... 78
- 9.31 SystemStatusChangeEvent ..... 78
- 9.32 ModelChangeEvents ..... 78
  - 9.32.1 General ..... 78
  - 9.32.2 NodeVersion Property ..... 78
  - 9.32.3 Views ..... 79
  - 9.32.4 Event Compression ..... 79
  - 9.32.5 BaseModelChangeEvent ..... 79
  - 9.32.6 GeneralModelChangeEvent ..... 79
  - 9.32.7 Guidelines for ModelChangeEvents ..... 79
- 9.33 SemanticChangeEvent ..... 80
  - 9.33.1 General ..... 80
  - 9.33.2 ViewVersion and NodeVersion Properties ..... 80
  - 9.33.3 Views ..... 80
  - 9.33.4 Event Compression ..... 80
- Annex A (informative) How to use the Address Space Model ..... 81
  - A.1 Overview ..... 81
  - A.2 Type definitions ..... 81
  - A.3 ObjectTypes ..... 81
  - A.4 VariableTypes ..... 81
    - A.4.1 General ..... 81
    - A.4.2 Properties or DataVariables ..... 81
    - A.4.3 Many Variables and / or structured DataTypes ..... 82
  - A.5 Views ..... 82
  - A.6 Methods ..... 83
  - A.7 Defining ReferenceTypes ..... 83
  - A.8 Defining ModellingRules ..... 83
- Annex B (informative) OPC UA Meta Model in UML ..... 84
  - B.1 Background ..... 84
  - B.2 Notation ..... 84
  - B.3 Meta Model ..... 85
    - B.3.1 Base ..... 85



B.3.2	ReferenceType .....	86
B.3.3	Predefined ReferenceTypes .....	87
B.3.4	Attributes .....	87
B.3.5	Object and ObjectType.....	88
B.3.6	EventNotifier .....	89
B.3.7	Variable and VariableType .....	89
B.3.8	Method.....	90
B.3.9	DataType .....	91
B.3.10	View.....	92
Annex C (normative) Graphical Notation .....		93
C.1	General.....	93
C.2	Notation .....	93
C.2.1	Overview.....	93
C.2.2	Simple Notation .....	93
C.2.3	Extended Notation .....	95

**FIGURES**

Figure 1 – AddressSpace Node diagrams ..... 3

Figure 2 – OPC UA Object Model ..... 5

Figure 3 – AddressSpace Node Model ..... 6

Figure 4 – Reference Model ..... 7

Figure 5 – Example of a Variable defined by a VariableType ..... 8

Figure 6 – Example of a Complex TypeDefinition ..... 9

Figure 7 – Object and its Components defined by an ObjectType ..... 10

Figure 8 – Permissions in the Address Space ..... 18

Figure 9 – Symmetric and Non-Symmetric References ..... 20

Figure 10 – Variables, VariableTypes and their DataTypes ..... 35

Figure 11 – DataType Model ..... 36

Figure 12 – Example of DataType Modelling ..... 39

Figure 13 – Subtyping TypeDefinitionNodes ..... 42

Figure 14 – The Fully-Inherited InstanceDeclarationHierarchy for BetaType ..... 44

Figure 15 – An Instance and its TypeDefinitionNode ..... 45

Figure 16 – Example for several References between InstanceDeclarations ..... 46

Figure 17 – Example on changing instances based on InstanceDeclarations ..... 48

Figure 18 – Example on changing InstanceDeclarations based on an InstanceDeclaration .. 49

Figure 19 – Use of the Standard ModellingRule Mandatory ..... 50

Figure 20 – Example using the Standard ModellingRules Optional and Mandatory ..... 51

Figure 21 – Example on using ExposesItsArray ..... 52

Figure 22 – Complex example on using ExposesItsArray ..... 52

Figure 23 – Example using OptionalPlaceholder with an Object and Variable ..... 52

Figure 24 – Example using OptionalPlaceholder with a Method ..... 53

Figure 25 – Example on using MandatoryPlaceholder for Object and Variable ..... 54

Figure 26 – Standard ReferenceType Hierarchy ..... 55

Figure 27 – Event Reference Example ..... 59

Figure 28 – Complex Event Reference Example ..... 60

Figure 29 – Standard EventType Hierarchy ..... 74

Figure 30 – Audit Behaviour of a Server ..... 75

Figure 31 – Audit Behaviour of an Aggregating Server ..... 76

Figure B.1 – Background of OPC UA Meta Model ..... 84

Figure B.2 – Notation (I) ..... 85

Figure B.3 – Notation (II) ..... 85

Figure B.4 – Base ..... 86

Figure B.5 – Reference and ReferenceType ..... 86

Figure B.6 – Predefined ReferenceTypes ..... 87

Figure B.7 – Attributes ..... 88

Figure B.8 – Object and ObjectType ..... 89

Figure B.9 – EventNotifier ..... 89

Figure B.10 – Variable and VariableType ..... 90

Figure B.11 – Method ..... 91

Figure B.12 – DataType ..... 92

Figure B.13 – View ..... 92

Figure C.1 – Example of a Reference connecting two Nodes ..... 94

Figure C.2 – Example of using a TypeDefinition inside a Node ..... 96

Figure C.3 – Example of exposing Attributes ..... 96

Figure C.4 – Example of exposing Properties inline ..... 97

**TABLES**

Table 1 – NodeClass Table Conventions ..... 4

Table 2 – Well-Known Roles ..... 13

Table 3 – Example Roles ..... 13

Table 4 – Example Nodes ..... 14

Table 5 – Example Role Assignment ..... 14

Table 6 – Examples of Evaluating Access ..... 14

Table 7 – Base NodeClass ..... 15

Table 9 – ReferenceType NodeClass ..... 19

Table 10 – View NodeClass ..... 22

Table 11 – Object NodeClass ..... 24

Table 12 – ObjectType NodeClass ..... 25

Table 13 – Variable NodeClass ..... 27

Table 14 – VariableType NodeClass ..... 32

Table 15 – Method NodeClass ..... 34

Table 16 – DataType NodeClass ..... 38

Table 17 – Overview of Attributes..... 40

Table 18 – The InstanceDeclarationHierarchy for BetaType ..... 43

Table 19 – The Fully-Inherited InstanceDeclarationHierarchy for BetaType ..... 43

Table 20 – Rule for ModellingRules Properties when Subtyping ..... 47

Table 21 – Properties of ModellingRules ..... 49

Table 22 – NodeId Definition ..... 60

Table 23 – IdentifierType Values ..... 61

Table 24 – NodeId Null Values ..... 61

Table 25 – QualifiedName Definition ..... 62

Table 26 – LocaleId Examples..... 62

Table 27 – LocalizedText Definition..... 62

Table 28 – Argument Definition ..... 63

Table 29 – TimeZoneDataType Definition..... 65

Table 30 – NamingRuleType Values..... 65

Table 31 – NodeClass Values ..... 65

Table 32 – EnumValueType Definition..... 66

Table 33 – OptionSet Definition..... 67

Table 34 – StructureDefinition Structure..... 69

Table 35 – EnumDefinition Structure ..... 69

Table 36 – StructureField Structure ..... 69

Table 37 – EnumField Structure ..... 70

Table 38 – PermissionType Definition ..... 70

Table 39 – AccessRestrictionsType Definition ..... 71

Table 40 – AccessLevelType Definition ..... 72

Table 41 – AccessLevelExType Definition ..... 72

Table 42 – EventNotifierType Definition ..... 73

Table 43 – Bit mask for WriteMask and UserWriteMask..... 73  
Table C.1 – Notation of Nodes depending on the NodeClass..... 94  
Table C.2 – Simple Notation of Nodes depending on the NodeClass ..... 95

## OPC FOUNDATION

---

### UNIFIED ARCHITECTURE –

#### FOREWORD

This specification is the specification for developers of OPC UA applications. The specification is a result of an analysis and design process to develop a standard interface to facilitate the development of applications by multiple vendors that shall inter-operate seamlessly together.

**Copyright © 2006-2018, OPC Foundation, Inc.**

#### AGREEMENT OF USE

##### COPYRIGHT RESTRICTIONS

Any unauthorized use of this specification may violate copyright laws, trademark laws, and communications regulations and statutes. This document contains information which is protected by copyright. All Rights Reserved. No part of this work covered by copyright herein may be reproduced or used in any form or by any means--graphic, electronic, or mechanical, including photocopying, recording, taping, or information storage and retrieval systems--without permission of the copyright owner.

OPC Foundation members and non-members are prohibited from copying and redistributing this specification. All copies must be obtained on an individual basis, directly from the OPC Foundation Web site <http://www.opcfoundation.org>.

##### PATENTS

The attention of adopters is directed to the possibility that compliance with or adoption of OPC specifications may require use of an invention covered by patent rights. OPC shall not be responsible for identifying patents for which a license may be required by any OPC specification, or for conducting legal inquiries into the legal validity or scope of those patents that are brought to its attention. OPC specifications are prospective and advisory only. Prospective users are responsible for protecting themselves against liability for infringement of patents.

##### WARRANTY AND LIABILITY DISCLAIMERS

WHILE THIS PUBLICATION IS BELIEVED TO BE ACCURATE, IT IS PROVIDED "AS IS" AND MAY CONTAIN ERRORS OR MISPRINTS. THE OPC FOUNDATION MAKES NO WARRANTY OF ANY KIND, EXPRESSED OR IMPLIED, WITH REGARD TO THIS PUBLICATION, INCLUDING BUT NOT LIMITED TO ANY WARRANTY OF TITLE OR OWNERSHIP, IMPLIED WARRANTY OF MERCHANTABILITY OR WARRANTY OF FITNESS FOR A PARTICULAR PURPOSE OR USE. IN NO EVENT SHALL THE OPC FOUNDATION BE LIABLE FOR ERRORS CONTAINED HEREIN OR FOR DIRECT, INDIRECT, INCIDENTAL, SPECIAL, CONSEQUENTIAL, RELIANCE OR COVER DAMAGES, INCLUDING LOSS OF PROFITS, REVENUE, DATA OR USE, INCURRED BY ANY USER OR ANY THIRD PARTY IN CONNECTION WITH THE FURNISHING, PERFORMANCE, OR USE OF THIS MATERIAL, EVEN IF ADVISED OF THE POSSIBILITY OF SUCH DAMAGES.

The entire risk as to the quality and performance of software developed using this specification is borne by you.

##### RESTRICTED RIGHTS LEGEND

This Specification is provided with Restricted Rights. Use, duplication or disclosure by the U.S. government is subject to restrictions as set forth in (a) this Agreement pursuant to DFARs 227.7202-3(a); (b) subparagraph (c)(1)(i) of the Rights in Technical Data and Computer Software clause at DFARs 252.227-7013; or (c) the Commercial Computer Software Restricted Rights clause at FAR 52.227-19 subdivision (c)(1) and (2), as applicable. Contractor / manufacturer are the OPC Foundation, 16101 N. 82nd Street, Suite 3B, Scottsdale, AZ, 85260-1830

##### COMPLIANCE

The OPC Foundation shall at all times be the sole entity that may authorize developers, suppliers and sellers of hardware and software to use certification marks, trademarks or other special designations to indicate compliance with these materials. Products developed using this specification may claim compliance or conformance with this specification if and only if the software satisfactorily meets the certification requirements set by the OPC Foundation. Products that do not meet these requirements may claim only that the product was based on this specification and must not claim compliance or conformance with this specification.

##### TRADEMARKS

Most computer and software brand names have trademarks or registered trademarks. The individual trademarks have not been listed here.

#### GENERAL PROVISIONS

Should any provision of this Agreement be held to be void, invalid, unenforceable or illegal by a court, the validity and enforceability of the other provisions shall not be affected thereby.

This Agreement shall be governed by and construed under the laws of the State of Minnesota, excluding its choice or law rules.

This Agreement embodies the entire understanding between the parties with respect to, and supersedes any prior understanding or agreement (oral or written) relating to, this specification.

#### ISSUE REPORTING

The OPC Foundation strives to maintain the highest quality standards for its published specifications, hence they undergo constant review and refinement. Readers are encouraged to report any issues and view any existing errata here: <http://www.opcfoundation.org/errata>.

**Revision 1.04 Highlights**

The following table includes the Mantis issues resolved with this revision.

Mantis ID	Summary	Resolution
<a href="#">3163</a>	Reference broken	In section 8.22 the reference to spec was fixed.
<a href="#">3127</a>	Element order of LocalizedText different from Part 6	Changed order in 8.5 from text / locale to locale / text to match Part 6 and implementations
<a href="#">3018</a>	Handling of DataType Encoding Information	<p>Added Property to DataType NodeClass in 5.8.3 containing information about data type definition. Added DataTypes for handling the information in 8.48, 8.49, 8.50, 8.51, and 8.52.</p> <p>Removed the old approach having DataTypeDictionaries. This effects 5.6.2, where Properties have been removed, 5.8, where the old approach was defined in detail, and 5.5.1 as well as 7, where the ReferenceType HasDefinition and its usage was removed.</p> <p>The old approach is moved to an annex of Part 5 and can still be applied by OPC UA Applications.</p>
<a href="#">3243</a>	Clarification on SemanticChange bit	Changed description in 5.6.2 explaining that SemanticChange bit also requires triggering SementicsChanged bit in subscription and does not have to be set if Property cannot change.
<a href="#">3535</a>	Need attribute to indicate atomicity	Added a new Attribute AccessLevelEx which contains a bits to indicate atomic access capability in 5.6.2
<a href="#">3306</a>	Clarification of Server and Source Time stamps	Added clarifying text to section 8.38
<a href="#">3161</a> , <a href="#">3181</a>	Clarification of OptionSet Value and ValueBits	Added clarifying text to Table 33 and 8.52
<a href="#">3681</a>	User Authentication Addition	Added Roles sections 4.8, 5.2.9,5.2.10 and 5.2.11
<a href="#">3416</a>	Instance declaration nodes can have an abstract type	Added clarifying text to section 6.2.1
<a href="#">2994</a> <a href="#">2995</a>	Meta data to indicate encryption is required	Added AccessRestrictions Attribute
<a href="#">3536</a>	No access level flag for optional IndexRange write	Added a new Attribute AccessLevelEx which contains a bit to indicate array index range write capability in 5.6.2
<a href="#">3676</a>	AccessRestrictions requires "Session required" flag	Added a new flag "SessionRequired" to AccessRestrictions in 5.2.11
<a href="#">3652</a>	Audio Data Type for Part 9	Added new DataType AudioDataType in 8.53
<a href="#">3504</a>	AccessLevel StatusWrite bit	Clarifying text added in 5.6.2
<a href="#">3511</a>	Subtyping Unions needs clarification	Clarifying text added in 8.42
<a href="#">3722</a>	Decimal DataType	Added new DataType Decimal in 8.54
<a href="#">3602</a>	UserAccess, UserExecutable and UserWriteMask clarification	Added clarification text to 5.2.8, 5.6.2 and 5.7.



<a href="#">3665</a>	Application of Modelling rules for Methods	Added text to OptionalPlaceholder 6.4.4.5.5 and MandatoryPlaceholder 6.4.4.5.6 modelling rules describing their use with Methods.
<a href="#">3797</a>	MaxStringLength	Added clarification text to 5.6.4.
<a href="#">3818</a>	ValueAsText applicability	Added clarification text to Table 13
<a href="#">3827</a>	BrowseNames for component variables for structures	Added BrowseName description to 5.6.4
<a href="#">3888</a>	Array Dimensions for StructureField fields	Added arrayDimensions to StructureField Table 36
<a href="#">3923</a>	ArrayDimensions description does not have meaning	Added clarification of ArrayDimensions in Variable NodeClass Table 13, VariableType NodeClass Table 14. Added arrayDimensions in Argument DataType Table 28



## OPC Unified Architecture Specification

### Part 3: Address Space Model

#### 1 Scope

This specification describes the OPC Unified Architecture (OPC UA) *AddressSpace* and its *Objects*. This Part is the OPC UA meta model on which OPC UA information models are based.

#### 2 Normative references

The following documents, in whole or in part, are normatively referenced in this document and are indispensable for its application. For dated references, only the edition cited applies. For undated references, the latest edition of the referenced document (including any amendments and errata) applies.

OPC 10000-1, *OPC Unified Architecture - Part 1: Overview and Concepts*

<http://www.opcfoundation.org/UA/Part1/>

OPC 10000-2, *OPC Unified Architecture - Part 2: Security Model*

<http://www.opcfoundation.org/UA/Part2/>

OPC 10000-4, *OPC Unified Architecture - Part 4: Services*

<http://www.opcfoundation.org/UA/Part4/>

OPC 10000-5, *OPC Unified Architecture - Part 5: Information Model*

<http://www.opcfoundation.org/UA/Part5/>

OPC 10000-6, *OPC Unified Architecture - Part 6: Mappings*

<http://www.opcfoundation.org/UA/Part6/>

OPC 10000-8, *OPC Unified Architecture - Part 8: Data Access*

<http://www.opcfoundation.org/UA/Part8/>

OPC 10000-9, *OPC Unified Architecture - Part 9: Alarms and Conditions*

<http://www.opcfoundation.org/UA/Part9/>

OPC 10000-11, *OPC Unified Architecture - Part 11: Historical Access*

<http://www.opcfoundation.org/UA/Part11/>

ISO/IEC 10918-1: Information technology – Digital compression and coding of continuous-tone still images: Requirements and guidelines

<https://www.iso.org/standard/18902.html>

ISO/IEC 15948: Information technology – Computer graphics and image processing – Portable Network Graphics (PNG): Functional specification

<https://www.iso.org/standard/29581.html>

ISO 639 (all parts): Codes for the representation of names of languages

<https://www.iso.org/iso-639-language-codes.html>

ISO 3166 (all parts): Codes for the representation of names of countries and their subdivisions

<https://www.iso.org/iso-3166-country-codes.html>

ISO/IEC/IEEE 60559:2011: Information technology – Microprocessor Systems – Floating-Point arithmetic

<https://www.iso.org/standard/57469.html>

IETF RFC 5646: Tags for Identifying Languages

<http://tools.ietf.org/html/rfc5646>

ISO 8601-2000: Data elements and interchange formats

<https://www.iso.org/standard/26780.html>

Unicode Annex15: Unicode Standard Annex #15: Unicode Normalization Forms

<http://www.unicode.org/reports/tr15/>

W3C XML Schema Definition Language (XSD) Part 2: DataTypes

<http://www.w3.org/TR/xmlschema-2/>

TAI: International Atomic Time

<http://www.bipm.org/en/bipm-services/timescales/tai.html>

### 3 Terms, definitions, abbreviations and conventions

#### 3.1 Terms and definitions

For the purposes of this document, the terms and definitions given in The following documents, in whole or in part, are normatively referenced in this document and are indispensable for its application. For dated references, only the edition cited applies. For undated references, the latest edition of the referenced document (including any amendments and errata) applies.

OPC 10000-1 as well as the following apply.

##### 3.1.1

###### **Data Type**

instance of a *Data Type Node* that is used together with the *Value Rank Attribute* to define the data type of a *Variable*

##### 3.1.2

###### **DataTypeId**

*NodeId* of a *Data Type Node*

##### 3.1.3

###### **Data Variable**

*Variables* that represent *values* of *Objects*, either directly or indirectly for complex *Variables*, where the *Variables* are always the *TargetNode* of a *HasComponent Reference*

##### 3.1.4

###### **EventType**

*ObjectType Node* that represents the type definition of an *Event*

##### 3.1.5

###### **Hierarchical Reference**

*Reference* that is used to construct hierarchies in the *AddressSpace*

Note 1 to entry: All hierarchical ReferenceTypes are derived from HierarchicalReferences.

##### 3.1.6

###### **InstanceDeclaration**

*Node* that is used by a complex *TypeDefinitionNode* to expose its complex structure

Note 1 to entry: It is an instance used by a type definition.

**3.1.7**

**ModellingRule**

metadata of an *InstanceDeclaration* that defines how the *InstanceDeclaration* will be used for instantiation and also defines subtyping rules for an *InstanceDeclaration*

**3.1.8**

**Property**

*Variables* that are the *TargetNode* for a *HasProperty Reference*

Note 1 to entry: *Properties* describe the characteristics of a *Node*.

**3.1.9**

**SourceNode**

*Node* having a *Reference* to another *Node*

EXAMPLE: In the *Reference* "A contains B", "A" is the *SourceNode*.

**3.1.10**

**TargetNode**

*Node* that is referenced by another *Node*

EXAMPLE: In the *Reference* "A Contains B", "B" is the *TargetNode*.

**3.1.11**

**TypeDefinitionNode**

*Node* that is used to define the type of another *Node*

Note 1 to entry: *ObjectType* and *VariableType Nodes* are *TypeDefinitionNodes*.

**3.1.12**

**VariableType**

*Node* that represents the type definition for a *Variable*

**3.2 Abbreviations**

- UA Unified Architecture
- UML Unified Modeling Language
- URI Uniform Resource Identifier
- W3C World Wide Web Consortium
- XML Extensible Markup Language

**3.3 Conventions**

**3.3.1 Conventions for AddressSpace figures**

*Nodes* and their *References* to each other are illustrated using figures. Figure 1 illustrates the conventions used in these figures.

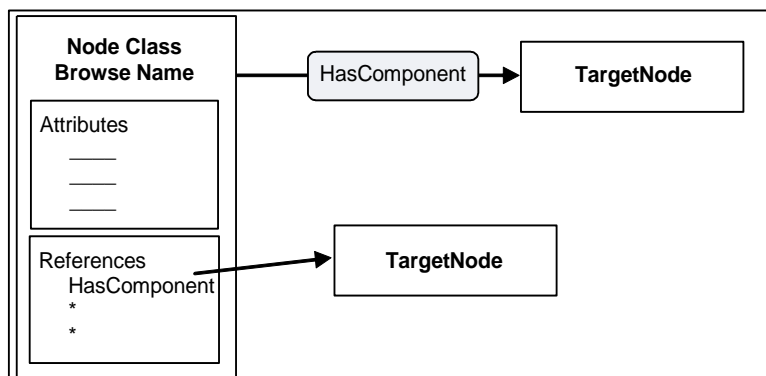

**Figure 1 – AddressSpace Node diagrams**

In these figures, rectangles represent *Nodes*. *Node* rectangles may be titled with one or two lines of text. When two lines are used, the first text line in the rectangle identifies the *NodeClass*

and the second line contains the *BrowseName*. When one line is used, it contains the *BrowseName*.

*Node* rectangles may contain boxes used to define their *Attributes* and *References*. Specific names in these boxes identify specific *Attributes* and *References*.

Shaded rectangles with rounded corners and with arrows passing through them represent *References*. The arrow that passes through them begins at the *SourceNode* and points to the *TargetNode*. *References* may also be shown by drawing an arrow that starts at the *Reference* name in the "References" box and ends at the *TargetNode*.

### 3.3.2 Conventions for defining NodeClasses

Clause 5 defines *AddressSpace NodeClasses*. Table 1 describes the format of the tables used to define *NodeClasses*.

**Table 1 – NodeClass Table Conventions**

Name	Use	Data Type	Description
<b>Attributes</b>			
"Attribute name"	"M" or "O"	Data type of the <i>Attribute</i>	Defines the <i>Attribute</i>
<b>References</b>			
"Reference name"	"1", "0..1" or "0..*"	Not used	Describes the use of the <i>Reference</i> by the <i>NodeClass</i>
<b>Standard Properties</b>			
"Property name"	"M" or "O"	Data type of the <i>Property</i>	Defines the <i>Property</i>

The Name column contains the name of the *Attribute*, the name of the *ReferenceType* used to create a *Reference* or the name of a *Property* referenced using the *HasProperty Reference*.

The Use column defines whether the *Attribute* or *Property* is mandatory (M) or optional (O). When mandatory the *Attribute* or *Property* shall exist for every *Node* of the *NodeClass*. For *References* it specifies the cardinality. The following values may apply:

- "0..\*" identifies that there are no restrictions, that is, the *Reference* does not have to be provided but there is no limitation how often it can be provided;
- "0..1" identifies that the *Reference* is provided at most once;
- "1" identifies that the *Reference* shall be provided exactly once.

The Data Type column contains the name of the *DataType* of the *Attribute* or *Property*. It is not used for *References*.

The Description column contains the description of the *Attribute*, the *Reference* or the *Property*.

Only this standard may define *Attributes*. Thus, all *Attributes* of the *NodeClass* are specified in the table and can only be extended by other parts of this series of standards.

This standard also defines *ReferenceTypes*, but *ReferenceTypes* can also be specified by a *Server* or by a client using the *NodeManagement Services* specified in OPC 10000-4. Thus, the *NodeClass* tables contained in this standard can contain the base *ReferenceType* called *References* identifying that any *ReferenceType* may be used for the *NodeClass*, including system specific *ReferenceTypes*. The *NodeClass* tables only specify how the *NodeClasses* can be used as *SourceNodes* of *References*, not as *TargetNodes*. If a *NodeClass* table allows a *ReferenceType* for its *NodeClass* to be used as *SourceNode*, this is also true for subtypes of the *ReferenceType*. However, subtypes of the *ReferenceType* may restrict its *SourceNodes*.

This standard defines *Properties*, but *Properties* can be defined by other standard organizations or vendors and *Nodes* can have *Properties* that are not standardised. *Properties* defined in this standard are defined by their name, which is mapped to the *BrowseName* having the *NamespaceIndex* 0, which represents the *Namespace* for OPC UA.

The Use column (optional or mandatory) does not imply a specific *ModellingRule* for *Properties*. Different *Server* implementations will choose to use *ModellingRules* appropriate for them.

## 4 AddressSpace concepts

### 4.1 Overview

The remainder of 4 defines the concepts of the *AddressSpace*. Clause 5 defines the *NodeClasses* of the *AddressSpace* representing the *AddressSpace* concepts. Clause 6 defines details on the type model for *ObjectTypes* and *VariableTypes*. Standard *ReferenceTypes*, *DataTypes* and *EventTypes* are defined in Clauses 7 to 9.

The informative Annex A describes general considerations on how to use the Address Space Model and the informative Annex B provides a UML Model of the Address Space Model. The normative Annex C defines a graphical notation for OPC UA data.

### 4.2 Object Model

The primary objective of the OPC UA *AddressSpace* is to provide a standard way for *Servers* to represent *Objects* to *Clients*. The OPC UA Object Model has been designed to meet this objective. It defines *Objects* in terms of *Variables* and *Methods*. It also allows relationships to other *Objects* to be expressed. Figure 2 illustrates the model.

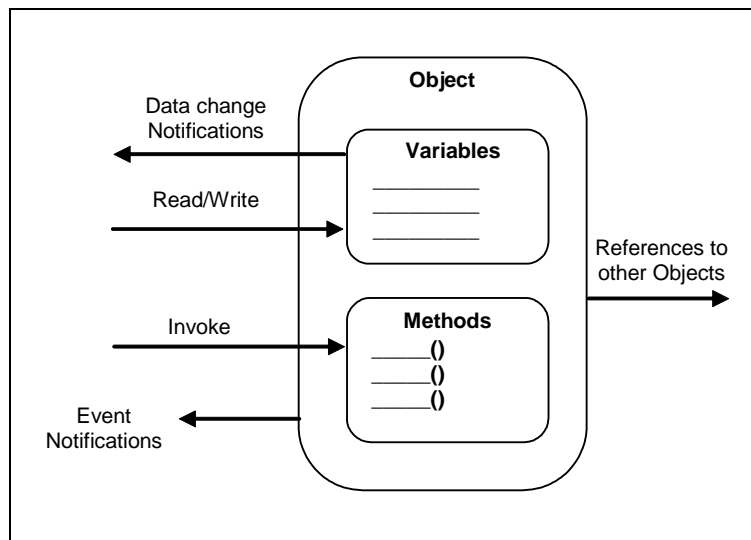

Figure 2 – OPC UA Object Model

The elements of this model are represented in the *AddressSpace* as *Nodes*. Each *Node* is assigned to a *NodeClass* and each *NodeClass* represents a different element of the Object Model. Clause 5 defines the *NodeClasses* used to represent this model.

### 4.3 Node Model

#### 4.3.1 General

The set of *Objects* and related information that the OPC UA *Server* makes available to *Clients* is referred to as its *AddressSpace*. The model for *Objects* is defined by the OPC UA Object Model (see 4.2).

Objects and their components are represented in the *AddressSpace* as a set of *Nodes* described by *Attributes* and interconnected by *References*. Figure 3 illustrates the model of a *Node* and the remainder of 4.3 discusses the details of the Node Model.

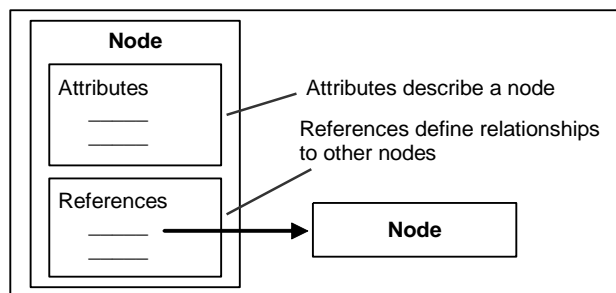

**Figure 3 – AddressSpace Node Model**

### 4.3.2 NodeClasses

*NodeClasses* are defined in terms of the *Attributes* and *References* that shall be instantiated (given values) when a *Node* is defined in the *AddressSpace*. *Attributes* are discussed in 4.3.3 and *References* in 4.3.4.

Clause 5 defines the *NodeClasses* for the OPC UA *AddressSpace*. These *NodeClasses* are referred to collectively as the metadata for the *AddressSpace*. Each *Node* in the *AddressSpace* is an instance of one of these *NodeClasses*. No other *NodeClasses* shall be used to define *Nodes*, and as a result, *Clients* and *Servers* are not allowed to define *NodeClasses* or extend the definitions of these *NodeClasses*.

### 4.3.3 Attributes

*Attributes* are data elements that describe *Nodes*. *Clients* can access *Attribute* values using Read, Write, Query, and Subscription/MonitoredItem *Services*. These *Services* are defined in OPC 10000-4.

*Attributes* are elementary components of *NodeClasses*. *Attribute* definitions are included as part of the *NodeClass* definitions in Clause 5 and, therefore, are not included in the *AddressSpace*.

Each *Attribute* definition consists of an attribute id (for attribute ids of *Attributes*, see OPC 10000-6), a name, a description, a data type and a mandatory/optional indicator. The set of *Attributes* defined for each *NodeClass* shall not be extended by *Clients* or *Servers*.

When a *Node* is instantiated in the *AddressSpace*, the values of the *NodeClass Attributes* are provided. The mandatory/optional indicator for the *Attribute* indicates whether the *Attribute* has to be instantiated.

### 4.3.4 References

*References* are used to relate *Nodes* to each other. They can be accessed using the browsing and querying *Services* defined in OPC 10000-4.

Like *Attributes*, they are defined as fundamental components of *Nodes*. Unlike *Attributes*, *References* are defined as instances of *ReferenceType Nodes*. *ReferenceType Nodes* are visible in the *AddressSpace* and are defined using the *ReferenceType NodeClass* (see 5.3).

The *Node* that contains the *Reference* is referred to as the *SourceNode* and the *Node* that is referenced is referred to as the *TargetNode*. The combination of the *SourceNode*, the *ReferenceType* and the *TargetNode* are used in OPC UA *Services* to uniquely identify *References*. Thus, each *Node* can reference another *Node* with the same *ReferenceType* only once. Any subtypes of concrete *ReferenceTypes* are considered to be equal to the base concrete *ReferenceTypes* when identifying *References* (see 5.3 for subtypes of *ReferenceTypes*). Figure 4 illustrates this model of a *Reference*.



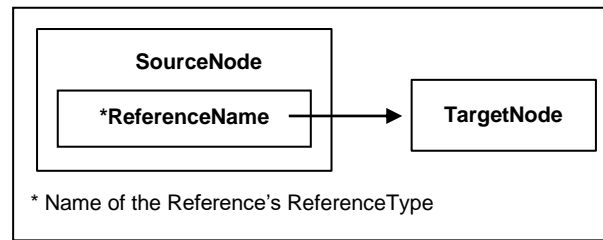

**Figure 4 – Reference Model**

The *TargetNode* of a *Reference* may be in the same *AddressSpace* or in the *AddressSpace* of another OPC UA *Server*. *TargetNodes* located in other *Servers* are identified in OPC UA *Services* using a combination of the remote *Server* name and the identifier assigned to the *Node* by the remote *Server*.

OPC UA does not require that *the TargetNode* exists, thus *References* may point to a *Node* that does not exist.

## 4.4 Variables

### 4.4.1 General

*Variables* are used to represent *values*. Two types of *Variables* are defined, *Properties* and *DataVariables*. They differ in the kind of data that they represent and whether they can contain other *Variables*.

### 4.4.2 Properties

*Properties* are *Server*-defined characteristics of *Objects*, *DataVariables* and other *Nodes*. *Properties* differ from *Attributes* in that they characterise *what* the *Node* represents, such as a device or a purchase order. *Attributes* define additional metadata that is instantiated for all *Nodes* from a *NodeClass*. *Attributes* are common to all *Nodes* of a *NodeClass* and only defined by this specification whereas *Properties* can be *Server*-defined.

For example, an *Attribute* defines the *DataType* of *Variables* whereas a *Property* can be used to specify the engineering unit of some *Variables*.

To prevent recursion, *Properties* are not allowed to have *Properties* defined for them. To easily identify *Properties*, the *BrowseName* of a *Property* shall be unique in the context of the *Node* containing the *Properties* (see 5.6.3 for details).

A *Node* and its *Properties* shall always reside in the same *Server*.

### 4.4.3 DataVariables

*DataVariables* represent the content of an *Object*. For example, a file *Object* may be defined that contains a stream of bytes. The stream of bytes may be defined as a *DataVariable* that is an array of bytes. *Properties* may be used to expose the creation time and owner of the file *Object*.

For example, if a *DataVariable* is defined by a data structure that contains two fields, “start`Time`” and “end`Time`” then it might have a *Property* specific to that data structure, such as “earliest`StartTime`”.

As another example, function blocks in control systems might be represented as *Objects*. The parameters of the function block, such as its setpoints, may be represented as *DataVariables*. The function block *Object* might also have *Properties* that describe its execution time and its type.

*DataVariables* may have additional *DataVariables*, but only if they are complex. In this case, their *DataVariables* shall always be elements of their complex definitions. Following the example introduced by the description of *Properties* in 4.4.2, the *Server* could expose “start`Time`” and “end`Time`” as separate components of the data structure.

As another example, a complex *DataVariable* may define an aggregate of temperature values generated by three separate temperature transmitters that are also visible in the *AddressSpace*. In this case, this complex *DataVariable* could define *HasComponent References* from it to the individual temperature values that it is composed of.

## 4.5 TypeDefinitionNodes

### 4.5.1 General

OPC UA Servers shall provide type definitions for *Objects* and *Variables*. The *HasTypeDefinition Reference* shall be used to link an instance with its type definition represented by a *TypeDefinitionNode*. Type definitions are required; however, OPC 10000-5 defines a *BaseObjectType*, a *PropertyType*, and a *BaseDataVariableType* so a *Server* can use such a base type if no more specialised type information is available. *Objects* and *Variables* inherit the *Attributes* specified by their *TypeDefinitionNode* (see 6.4 for details).

In some cases, the *NodeId* used by the *HasTypeDefinition Reference* will be well-known to *Clients* and *Servers*. Organizations may define *TypeDefinitionNodes* that are well-known in the industry. Well-known *NodeIds* of *TypeDefinitionNodes* provide for commonality across OPC UA Servers and allow *Clients* to interpret the *TypeDefinitionNode* without having to read it from the *Server*. Therefore, *Servers* may use well-known *NodeIds* without representing the corresponding *TypeDefinitionNodes* in their *AddressSpace*. However, the *TypeDefinitionNodes* shall be provided for generic *Clients*. These *TypeDefinitionNodes* may exist in another *Server*.

The following example, illustrated in Figure 5, describes the use of the *HasTypeDefinition Reference*. In this example, a setpoint parameter “SP” is represented as a *DataVariable* in the *AddressSpace*. This *DataVariable* is part of an *Object* not shown in the figure.

To provide for a common setpoint definition that can be used by other *Objects*, a specialised *VariableType* is used. Each setpoint *DataVariable* that uses this common definition will have a *HasTypeDefinition Reference* that identifies the common “SetPoint” *VariableType*.

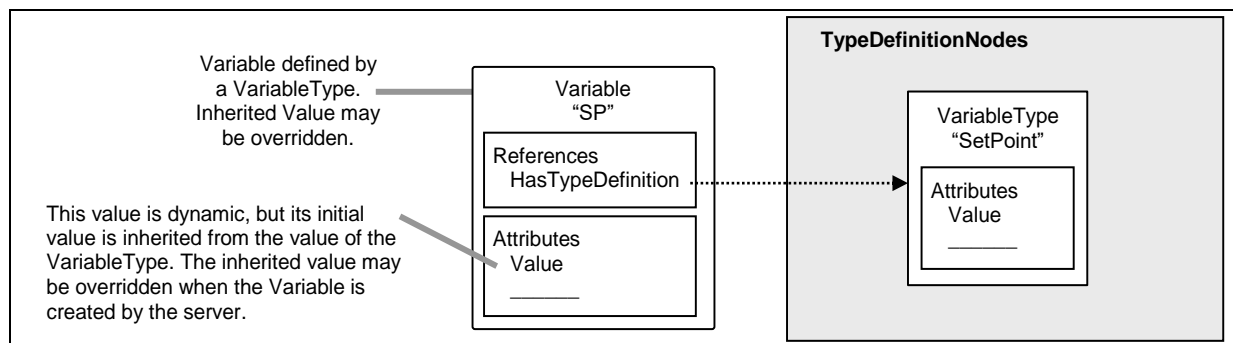
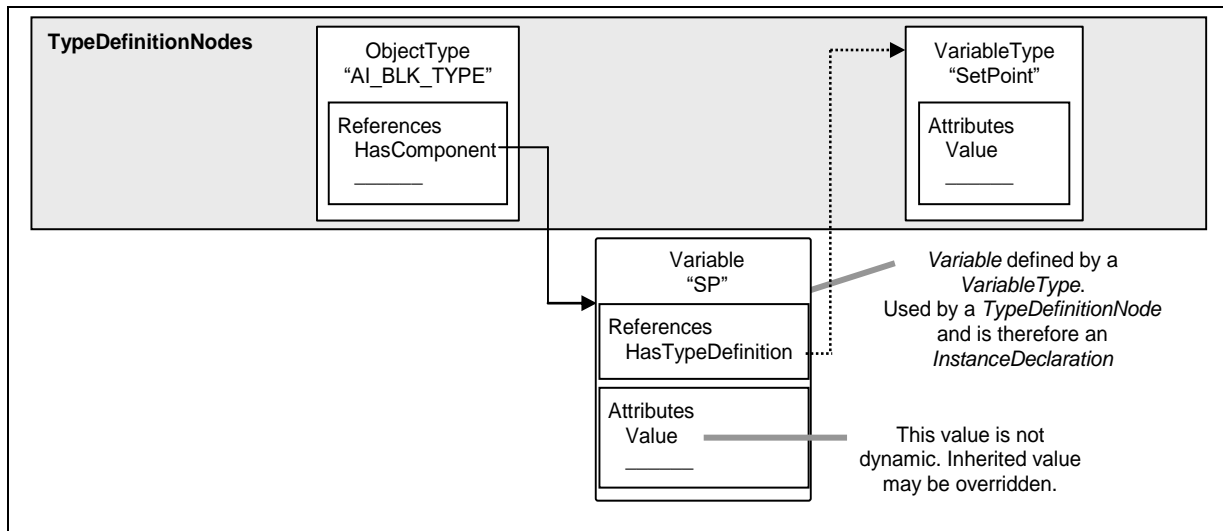

Figure 5 – Example of a Variable defined by a VariableType

### 4.5.2 Complex TypeDefinitionNodes and their InstanceDeclarations

*TypeDefinitionNodes* can be complex. A complex *TypeDefinitionNode* also defines *References* to other *Nodes* as part of the type definition. The *ModellingRules* defined in 6.4.4 specify how those *Nodes* are handled when creating an instance of the type definition.

A *TypeDefinitionNode* references instances instead of other *TypeDefinitionNodes* to allow unique names for several instances of the same type, to define default values and to add *References* for those instances that are specific to this complex *TypeDefinitionNode* and not to the *TypeDefinitionNode* of the instance. For example, in Figure 6 the *ObjectType* “AI\_BLK\_TYPE”, representing a function block, has a *HasComponent Reference* to a *Variable* “SP” of the *VariableType* “SetPoint”. “AI\_BLK\_TYPE” could have an additional setpoint *Variable* of the same type using a different name. It could add a *Property* to the *Variable* that was not defined by its *TypeDefinitionNode* “SetPoint”. And it could define a default value for “SP”, that is, each instance of “AI\_BLK\_TYPE” would have a *Variable* “SP” initially set to this value.



**Figure 6 – Example of a Complex TypeDefinition**

This approach is commonly used in object-oriented programming languages in which the variables of a class are defined as instances of other classes. When the class is instantiated, each variable is also instantiated, but with the default values (constructor values) defined for the containing class. That is, typically, the constructor for the component class runs first, followed by the constructor for the containing class. The constructor for the containing class may override component values set by the component class.

To distinguish instances used for the type definitions from instances that represent real data, those instances are called *InstanceDeclarations*. However, this term is used to simplify this specification, if an instance is an *InstanceDeclaration* or not is only visible in the *AddressSpace* by following its *References*. Some instances may be shared and therefore referenced by *TypeDefinitionNodes*, *InstanceDeclarations* and instances. This is similar to class variables in object-oriented programming languages.

**4.5.3 Subtyping**

This standard allows subtyping of type definitions. The subtyping rules are defined in Clause 6. Subtyping of *ObjectTypes* and *VariableTypes* allows:

- *Clients* that only know the supertype to handle an instance of the subtype as if it were an instance of the supertype;
- instances of the supertype to be replaced by instances of the subtype;
- specialised types that inherit common characteristics of the base type.

In other words, subtypes reflect the structure defined by their supertype but may add additional characteristics. For example, a vendor may wish to extend a general “TemperatureSensor” *VariableType* by adding a *Property* providing the next maintenance interval. The vendor would do this by creating a new *VariableType* which is a *TargetNode* for a *HasSubtype* reference from the original *VariableType* and adding the new *Property* to it.

**4.5.4 Instantiation of complex TypeDefinitionNodes**

The instantiation of complex *TypeDefinitionNodes* depends on the *ModellingRules* defined in 6.4.4. However, the intention is that instances of a type definition will reflect the structure defined by the *TypeDefinitionNode*. Figure 7 shows an instance of the *TypeDefinitionNode* “AI\_BLK\_TYPE”, where the *ModellingRule Mandatory*, defined in 6.4.4.5.2, was applied for its containing *Variable*. Thus, an instance of “AI\_BLK\_TYPE”, called AI\_BLK\_1”, has a *HasTypeDefinition Reference* to “AI\_BLK\_TYPE”. It also contains a *Variable* “SP” having the same *BrowseName* as the *Variable* “SP” used by the *TypeDefinitionNode* and thereby reflects the structure defined by the *TypeDefinitionNode*.

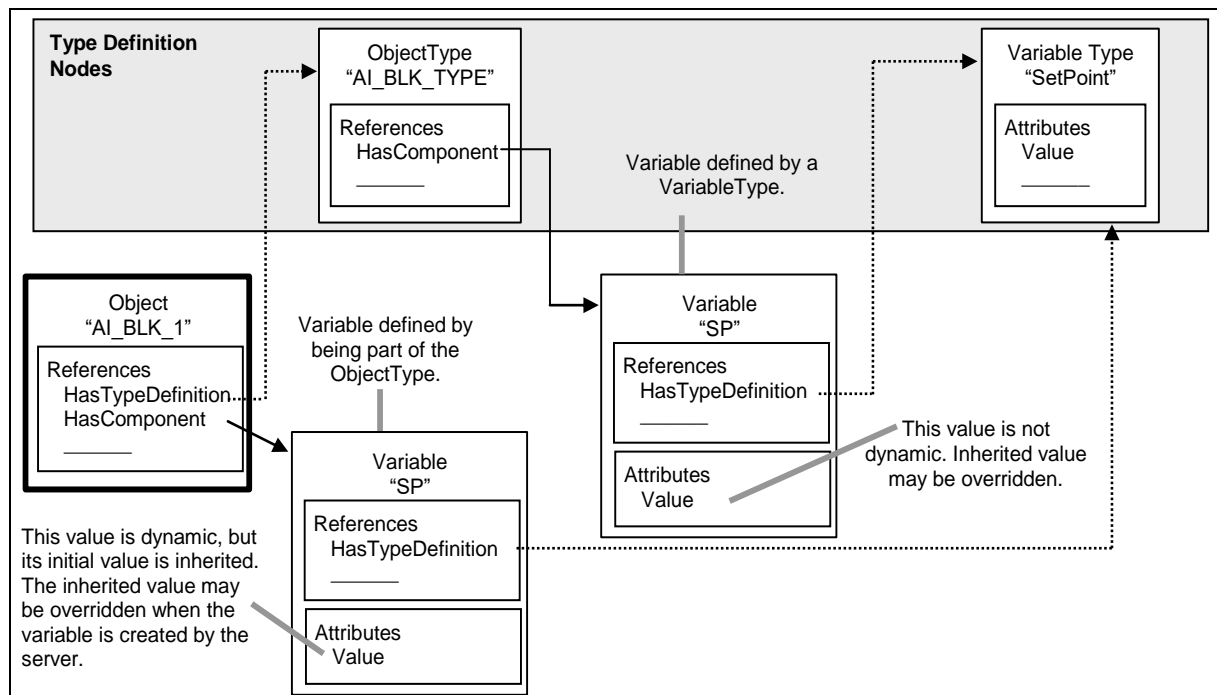

**Figure 7 – Object and its Components defined by an ObjectType**

A client knowing the *ObjectType* “AI\_BLK\_TYPE” can use this knowledge to directly browse to the containing *Nodes* for each instance of this type. This allows programming against the *TypeDefinitionNode*. For example, a graphical element may be programmed in the client that handles all instances of “AI\_BLK\_TYPE” in the same way by showing the value of “SP”.

There are several constraints related to programming against the *TypeDefinitionNode*. A *TypeDefinitionNode* or an *InstanceDeclaration* shall never reference two *Nodes* having the same *BrowseName* using forward *hierarchical References*. Instances based on *InstanceDeclarations* shall always keep the same *BrowseName* as the *InstanceDeclaration* they are derived from. A special *Service* defined in OPC 10000-4 called *TranslateBrowsePathsToNodeIds* may be used to identify the instances based on the *InstanceDeclarations*. Using the simple *Browse Service* might not be sufficient since the uniqueness of the *BrowseName* is only required for *TypeDefinitionNodes* and *InstanceDeclarations*, not for other instances. Thus, “AI\_BLK\_1” may have another *Variable* with the *BrowseName* “SP”, although this one would not be derived from an *InstanceDeclaration* of the *TypeDefinitionNode*.

Instances derived from an *InstanceDeclaration* shall be of the same *TypeDefinitionNode* or a subtype of this *TypeDefinitionNode*.

A *TypeDefinitionNode* and its *InstanceDeclarations* shall always reside in the same *Server*. However, instances may point with their *HasTypeDefinition Reference* to a *TypeDefinitionNode* in a different *Server*.

## 4.6 Event Model

### 4.6.1 General

The Event Model defines a general purpose eventing system that can be used in many diverse vertical markets.

*Events* represent specific transient occurrences. System configuration changes and system errors are examples of *Events*. *Event Notifications* report the occurrence of an *Event*. *Events* defined in this document are not directly visible in the OPC UA *AddressSpace*. *Objects* and *Views* can be used to subscribe to *Events*. The *EventNotifier Attribute* of those *Nodes* identifies if the *Node* allows subscribing to *Events*. *Clients* subscribe to such *Nodes* to receive *Notifications* of *Event* occurrences.

*Event Subscriptions* use the *Monitoring and Subscription Services* defined in OPC 10000-4 to subscribe to the *Event Notifications* of a *Node*.

Any OPC UA *Server* that supports eventing shall expose at least one *Node* as *EventNotifier*. The *Server Object* defined in OPC 10000-5 is used for this purpose. *Events* generated by the *Server* are available via this *Server Object*. A *Server* is not expected to produce *Events* if the connection to the event source is down for some reason (i.e. the system is offline).

*Events* may also be exposed through other *Nodes* anywhere in the *AddressSpace*. These *Nodes* (identified via the *EventNotifier Attribute*) provide some subset of the *Events* generated by the *Server*. The position in the *AddressSpace* dictates what this subset will be. For example, a process area *Object* representing a functional area of the process would provide *Events* originating from that area of the process only. It should be noted that this is only an example and it is fully up to the *Server* to determine what *Events* should be provided by which *Node*.

#### 4.6.2 EventTypes

Each *Event* is of a specific *EventType*. A *Server* may support many types. This part defines the *BaseEventType* that all other *EventTypes* derive from. It is expected that other companion specifications will define additional *EventTypes* deriving from the base types defined in this part.

The *EventTypes* supported by a *Server* are exposed in the *AddressSpace* of a *Server*. *EventTypes* are represented as *ObjectTypes* in the *AddressSpace* and do not have a special *NodeClass* associated to them. OPC 10000-5 defines how a *Server* exposes the *EventTypes* in detail.

*EventTypes* defined in this document are specified as abstract and therefore never instantiated in the *AddressSpace*. Event occurrences of those *EventTypes* are only exposed via a *Subscription*. *EventTypes* exist in the *AddressSpace* to allow *Clients* to discover the *EventType*. This information is used by a client when establishing and working with *Event Subscriptions*. *EventTypes* defined by other parts of this series of standards or companion specifications as well as *Server* specific *EventTypes* may be defined as not abstract and therefore instances of those *EventTypes* may be visible in the *AddressSpace* although *Events* of those *EventTypes* are also accessible via the *Event Notification* mechanisms.

Standard *EventTypes* are described in Clause 9. Their representation in the *AddressSpace* is specified in OPC 10000-5.

#### 4.6.3 Event Categorization

*Events* can be categorised by creating new *EventTypes* which are subtypes of existing *EventTypes* but do not extend an existing type. They are used only to identify an event as being of the new *EventType*. For example, the *EventType* *DeviceFailureEventType* could be subtyped into *TransmitterFailureEventType* and *ComputerFailureEventType*. These new subtypes would not add new *Properties* or change the semantic inherited from the *DeviceFailureEventType* other than purely for categorization of the *Events*.

*Event* sources can also be organised into groups by using the *Event ReferenceTypes* described in 7.16 and 7.18. For example, a *Server* may define *Objects* in the *AddressSpace* representing *Events* related to physical devices, or *Event* areas of a plant or functionality contained in the *Server*. *Event References* would be used to indicate which *Event* sources represent physical devices and which ones represent some *Server*-based functionality. In addition, *References* can be used to group the physical devices or *Server*-based functionality into hierarchical *Event* areas. In some cases, an *Event* source may be categorised as being both a device and a *Server* function. In this case, two relationships would be established. Refer to the description of the *Event ReferenceTypes* for additional examples.

*Clients* can select a category or categories of *Events* by defining content filters that include terms specifying the *EventType* of the *Event* or a grouping of *Event* sources. The two mechanisms allow for a single *Event* to be categorised in multiple manners. A client could obtain all *Events* related to a physical device or all failures of a particular device.

## 4.7 Methods

*Methods* are “lightweight” functions, whose scope is bounded by an owning (see Note) *Object*, similar to the methods of a class in object-oriented programming or an owning *ObjectType*, similar to static methods of a class. *Methods* are invoked by a client, proceed to completion on the *Server* and return the result to the client. The lifetime of the *Method's* invocation instance begins when the client calls the *Method* and ends when the result is returned.

NOTE The owning *Object* or *ObjectType* is specified in the service call when invoking the *Method*.

While *Methods* may affect the state of the owning *Object*, they have no explicit state of their own. In this sense, they are stateless. *Methods* can have a varying number of input arguments and return resultant arguments. Each *Method* is described by a *Node* of the *Method NodeClass*. This *Node* contains the metadata that identifies the *Method's* arguments and describes its behaviour.

*Methods* are invoked by using the Call *Service* defined in OPC 10000-4.

*Clients* discover the *Methods* supported by a *Server* by browsing for the owning *Objects References* that identify their supported *Methods*.

## 4.8 Roles

### 4.8.1 Overview

A *Role* is a function assumed by a *Client* when it accesses a *Server*. *Roles* are used to separate authentication (determining who a *Client* is) from authorization (determining what the *Client* is allowed to do). By separating these tasks *Servers* can allow centralized services to manage user identities and credentials while the *Server* only manages the *Permissions* on its *Nodes* assigned to *Roles*.

The set of *Roles* supported by a *Server* are published as components of the *Roles Object* defined in OPC 10000-5. *Servers* should define a base set of *Roles* and allow configuration *Clients* to add system specific *Roles*.

When a *Session* is created, the *Server* must determine what *Roles* are granted to that *Session*. This specification defines standard mapping rules which *Servers* may support. *Servers* may also use vendor specific mapping rules in addition to or instead of the standard rules.

The standard mapping rules allow *Roles* to be granted based on:

- User identity;
- Application identity;
- Endpoint;

User identity mappings can be based on user names, user certificates or user groups. Well known groups include ‘AuthenticatedUser’ (any user with valid credentials) and ‘Anonymous’ (no user credentials provided).

Application identity mappings are based on the *ApplicationUri* specified in the *Client Certificate*. Application identity can only be enforced if the *Client* proves possession of a trusted *Certificate* by using it to create a *Secure Channel* or by providing a signature in *ActivateSession* (see OPC 10000-4).

Endpoint identity mappings are based on the URL used to connect to the *Server*. Endpoint identity can be used to restrict access to *Clients* running on particular networks.

OPC 10000-5 defines the *Objects*, *Methods* and *DataTypes* used to represent and manage these mapping rules in the *Address Space*.

### 4.8.2 Well Known Roles

All *Servers* should support the well-known *Roles* which are defined in Table 2. The *NodeIds* for the well-known *Roles* are defined in OPC 10000-6.

**Table 2 – Well-Known Roles**

BrowseName	Suggested Permissions
Anonymous	The <i>Role</i> has very limited access for use when a <i>Session</i> has anonymous credentials.
AuthenticatedUser	The <i>Role</i> has limited access for use when a <i>Session</i> has valid non-anonymous credentials but has not been explicitly granted access to a <i>Role</i> .
Observer	The <i>Role</i> is allowed to browse, read live data, read historical data/events or subscribe to data/events.
Operator	The <i>Role</i> is allowed to browse, read live data, read historical data/events or subscribe to data/events. In addition, the <i>Session</i> is allowed to write some live data and call some <i>Methods</i> .
Engineer	The <i>Role</i> is allowed to browse, read/write configuration data, read historical data/events, call <i>Methods</i> or subscribe to data/events.
Supervisor	The <i>Role</i> is allowed to browse, read live data, read historical data/events, call <i>Methods</i> or subscribe to data/events.
ConfigureAdmin	The <i>Role</i> is allowed to change the non-security related configuration settings.
SecurityAdmin	The <i>Role</i> is allowed to change security related settings.

**4.8.3 Evaluating Permissions with Roles**

When a *Client* attempts to access a *Node*, the *Server* goes through the list of *Roles* granted to the *Session* and logically ORs the *Permissions* for the *Role* on the *Node*. If there are no *Node specific Permissions* then the default *Permissions* for the *Role* in the *DefaultRolePermissions Property* of the *NamespaceMetadata* for the namespace the *Node* belongs to are used (see OPC 10000-5). The resulting mask is the effective *Permissions*. If the bits corresponding to current operation are set, then the operation can proceed. If they are not set the *Server* returns *Bad\_UserAccessDenied*.

*Roles* appear under the *Roles Object* in the *Server Address Space*. Each *Role* has mapping rules defined which appear as *Properties* of the *Role Object* (see OPC 10000-5). The examples shown in Table 3 illustrate how the standard mapping rules can be used to determine which *Roles* a *Session* has access to and, consequently, the *Permissions* that are granted to the *Session*.

**Table 3 – Example Roles**

Role	Mapping Rules	Description
Anonymous	Identities = Anonymous Applications = Endpoints =	An identity mapping rule that specifies the <i>Role</i> applies to anonymous users.
AuthenticatedUser	Identities = AuthenticatedUser Applications = Endpoints =	An identity mapping rule that specifies the <i>Role</i> applies to authenticated users.
Operator1	Identities = User with name 'Joe' Applications = urn:OperatorStation1 Endpoints =	An identity mapping rule that specifies specific users that have access to the <i>Role</i> with a application rule that restricts access to a single <i>Client</i> application.
Operator2	Identities = Users with name 'Joe' or 'Ann' Applications = urn:OperatorStation2 Endpoints =	An identity mapping rule that specifies specific users that have access to the <i>Role</i> with a application rule that restricts access to a single <i>Client</i> application.
Supervisor	Identities = User with name 'Root' Applications = Endpoints =	An identity mapping rule that specifies specific users that have access to the <i>Role</i>

Administrator	Identities = User with name 'Root' Applications = Endpoints = opc.tcp://127.0.0.1:48000	An identity mapping rule that specifies specific users that have access to the Role when they connect via a specific Endpoint.
---------------	---	--

The examples also make use of the *Nodes* defined in Table 4. The table specifies the value of the *RolePermissions Attribute* for each *Node*.

**Table 4 – Example Nodes**

Node	Role Permissions
Unit1.Measurement	AuthenticatedUser = Browse Operator1 = Browse, Read
Unit2.Measurement	AuthenticatedUser = Browse Operator2 = Browse, Read
SetPoint	AuthenticatedUser = Browse Operator1 and Operator2 = Browse, Read, Write Supervisor = Browse, Read
DisableDevice	AuthenticatedUser = Browse Operator1 and Operator2 = Browse, Read Administrator = Browse, Read, Write

When a *Client* creates a *Session* the *Roles* assigned to the *Session* depend on the rules defined for each *Role*. Table 5 lists the assigned *Roles* for different *Sessions* created with different *Users*, *Client* applications and *Endpoints*.

**Table 5 – Example Role Assignment**

User Provided by Client	Roles Assigned to Session
Anonymous	Anonymous
Sam	AuthenticatedUser
Joe using OperatorStation1 application.	AuthenticatedUser, Operator1
Joe using OperatorStation2 application.	AuthenticatedUser, Operator2
Joe using generic application.	AuthenticatedUser
Root using OperatorStation1 application.	AuthenticatedUser, Supervisor
Root using generic application and 127.0.0.1 endpoint.	AuthenticatedUser, Supervisor, Administrator
Root using generic application and another endpoint.	AuthenticatedUser, Supervisor

When a *Client* application accesses a *Node* the *RolePermissions* for the *Node* are compared to the *Roles* assigned to the *Session*. Any *Permissions* available to at least one *Role* is granted to the *Client*. Table 6 provides a number of scenarios and examples and the resulting decision on access.

**Table 6 – Examples of Evaluating Access**

Use Case	Role Permissions
Anonymous user on localhost browses Unit1.Measurement Node.	Access denied because no rule defined for Anonymous users.
User 'Sam' using OperatorStation1 application browses Unit1.Measurement Node.	Allowed because AuthenticatedUser is granted Browse Permission.
User 'Sam' using OperatorStation2 application reads <i>Value</i> of Unit1.Measurement Node.	Access denied because AuthenticatedUser is not granted Read Permission.



User 'Joe' using OperatorStation1 application reads <i>Value</i> of Unit1.Measurement <i>Node</i> .	Allowed because Operator1 is granted Read <i>Permission</i> .
User 'Joe' using OperatorStation2 application reads <i>Value</i> of Unit1.Measurement <i>Node</i> .	Access denied because AuthenticatedUser and Operator2 are not granted Read <i>Permission</i> .
User 'Joe' using generic OPC UA application reads <i>Value</i> of Measurement <i>Node</i> .	Access denied because AuthenticatedUser is not granted Read <i>Permission</i> .
User 'Joe' using OperatorStation1 application write <i>Value</i> of SetPoint <i>Node</i> .	Allowed because Operator1 is granted Write <i>Permission</i> .
User 'Root' using OperatorStation1 application write the <i>Value</i> of SetPoint <i>Node</i> .	Denied because AuthenticatedUser and Supervisor are not granted Write <i>Permission</i> .
User 'Joe' using OperatorStation1 application write Value of DisableDevice <i>Node</i> .	Access denied because AuthenticatedUser and Operator1 are not granted Write <i>Permission</i> .
User 'Root' using OperatorStation1 application write the <i>Value</i> of DisableDevice <i>Node</i> .	Access denied because AuthenticatedUser and Supervisor are not granted Write <i>Permission</i> .
User 'Root' using endpoint 127.0.0.1 to write <i>Value</i> of DisableDevice <i>Node</i> .	Allowed because Administrator is granted Write <i>Permission</i> .

## 5 Standard NodeClasses

### 5.1 Overview

Clause 5 defines the *NodeClasses* used to define *Nodes* in the OPC UA *AddressSpace*. *NodeClasses* are derived from a common *Base NodeClass*. This *NodeClass* is defined first, followed by those used to organise the *AddressSpace* and then by the *NodeClasses* used to represent *Objects*.

The *NodeClasses* defined to represent *Objects* fall into three categories: those used to define instances, those used to define types for those instances and those used to define data types. Subclause 6.3 describes the rules for subtyping and 6.4 the rules for instantiation of the type definitions.

### 5.2 Base NodeClass

#### 5.2.1 General

The OPC UA Address Space Model defines a *Base NodeClass* from which all other *NodeClasses* are derived. The derived *NodeClasses* represent the various components of the OPC UA Object Model (see 4.2). The *Attributes* of the *Base NodeClass* are specified in Table 7. There are no *References* specified for the *Base NodeClass*.

**Table 7 – Base NodeClass**

Name	Use	Data Type	Description
<b>Attributes</b>			
NodId	M	NodId	See 5.2.2
NodeClass	M	NodeClass	See 5.2.3
BrowseName	M	QualifiedName	See 5.2.4
DisplayName	M	LocalizedText	See 5.2.5
Description	O	LocalizedText	See 5.2.6
WriteMask	O	AttributeWriteMask	See 5.2.7
UserWriteMask	O	AttributeWriteMask	See 5.2.8
RolePermissions	O	RolePermissionType[]	See 5.2.9
UserRolePermissions	O	RolePermissionType[]	See 5.2.10
AccessRestrictions	O	AccessRestrictionsType	See 5.2.11
<b>References</b>			
			No <i>References</i> specified for this <i>NodeClass</i>

### 5.2.2 NodeId

*Nodes* are unambiguously identified using a constructed identifier called the *NodeId*. Some *Servers* may accept alternative *NodeIds* in addition to the canonical *NodeId* represented in this *Attribute*. A *Server* shall persist the *NodeId* of a *Node*, that is, it shall not generate new *NodeIds* when rebooting. The structure of the *NodeId* is defined in 8.2.

### 5.2.3 NodeClass

The *NodeClass Attribute* identifies the *NodeClass* of a *Node*. Its data type is defined in 8.30.

### 5.2.4 BrowseName

*Nodes* have a *BrowseName Attribute* that is used as a non-localised human-readable name when browsing the *AddressSpace* to create paths out of *BrowseNames*. The *TranslateBrowsePathsToNodeIds Service* defined in OPC 10000-4 can be used to follow a path constructed of *BrowseNames*.

A *BrowseName* should never be used to display the name of a *Node*. The *DisplayName* should be used instead for this purpose.

Unlike *NodeIds*, the *BrowseName* cannot be used to unambiguously identify a *Node*. Different *Nodes* may have the same *BrowseName*.

Subclause 8.3 defines the structure of the *BrowseName*. It contains a namespace and a string. The namespace is provided to make the *BrowseName* unique in some cases in the context of a *Node* (e.g. *Properties* of a *Node*) although not unique in the context of the *Server*. If different organizations define *BrowseNames* for *Properties*, the namespace of the *BrowseName* provided by the organization makes the *BrowseName* unique, although different organizations may use the same string having a slightly different meaning.

*Servers* may often choose to use the same namespace for the *NodeId* and the *BrowseName*. However, if they want to provide a standard *Property*, its *BrowseName* shall have the namespace of the standards body although the namespace of the *NodeId* reflects something else, for example the local *Server*.

It is recommended that standard bodies defining standard type definitions use their namespace for the *NodeId* of the *TypeDefinitionNode* as well as for the *BrowseName* of the *TypeDefinitionNode*.

The string-part of the *BrowseName* is case sensitive. That is, *Clients* shall consider them case sensitive. *Servers* are allowed to handle *BrowseNames* passed in *Service* requests as case insensitive. Examples are the *TranslateBrowsePathsToNodeIds Service* or *Event filter*.

### 5.2.5 DisplayName

The *DisplayName Attribute* contains the localised name of the *Node*. *Clients* should use this *Attribute* if they want to display the name of the *Node* to the user. They should not use the *BrowseName* for this purpose. The *Server* may maintain one or more localised representations for each *DisplayName*. *Clients* negotiate the locale to be returned when they open a session with the *Server*. Refer to OPC 10000-4 for a description of session establishment and locales. Subclause 8.5 defines the structure of the *DisplayName*. The string part of the *DisplayName* is restricted to 512 characters.

### 5.2.6 Description

The optional *Description Attribute* shall explain the meaning of the *Node* in a localised text using the same mechanisms for localisation as described for the *DisplayName* in 5.2.5.

### 5.2.7 WriteMask

The optional *WriteMask Attribute* exposes the possibilities of a client to write the *Attributes* of the *Node*. The *WriteMask Attribute* does not take any user access rights into account, that is, although an *Attribute* is writable this may be restricted to a certain user/user group.

If the OPC UA *Server* does not have the ability to get the *WriteMask* information for a specific *Attribute* from the underlying system, it should state that it is writable. If a write operation is

called on the *Attribute*, the *Server* should transfer this request and return the corresponding *StatusCode* if such a request is rejected. *StatusCodes* are defined in OPC 10000-4.

The *AttributeWriteMask DataType* is defined in 0.

### 5.2.8 UserWriteMask

The optional *UserWriteMask Attribute* exposes the possibilities of a client to write the *Attributes* of the *Node* taking user access rights into account. It uses the *AttributeWriteMask DataType* which is defined in 0.

The *UserWriteMask Attribute* can only further restrict the *WriteMask Attribute*, when it is set to not writable in the general case that applies for every user.

*Clients* cannot assume an *Attribute* can be written based on the *UserWriteMask Attribute*. It is possible that the *Server* may return an access denied error due to some server specific change which was not reflected in the state of this *Attribute* at the time the *Client* accessed it.

### 5.2.9 RolePermissions

The optional *RolePermissions Attribute* specifies the *Permissions* that apply to a *Node* for all *Roles* which have access to the *Node*. The value of the *Attribute* is an array of *RolePermissionType Structures* (see Table 8).

**Table 8 – RolePermissionType**

Name	Type	Description
RolePermissionType	Structure	Specifies the <i>Permissions</i> for a <i>Role</i>
roleId	NodeId	The <i>NodeId</i> of the <i>Role Object</i> .
permissions	PermissionType	A mask specifying which <i>Permissions</i> are available to the <i>Role</i> .

*Servers* may allow administrators to write to the *RolePermissions Attribute*.

If not specified, the value of *DefaultRolePermissions Property* from the *NamespaceMetadata Object* associated with the *Node* shall be used instead. If the *NamespaceMetadata Object* does not define the *Property* or does not exist, then the *Server* should not publish any information about how it manages *Permissions*.

If a *Server* supports *Permissions* for a particular *Namespace* it shall add the *DefaultRolePermissions Property* to the *NamespaceMetadata Object* for that *Namespace* (see Figure 8). If a particular *Node* in the *Namespace* needs to override the default values, the *Server* adds the *RolePermissions Attribute* to the *Node*. The *DefaultRolePermissions Property* and *RolePermissions Attribute* shall only be readable by administrators. If a *Server* allows the *Permissions* to be changed these values shall be writeable. If the *Server* allows the *Permissions* to be overridden for a particular *Node* but does not currently have any *Node Permissions* configured, then the value of the *Attribute* shall be an empty array. If the administrator wishes to remove overridden *Permissions*, an empty array shall be written to this *Attribute*. *Servers* shall prevent *Permissions* from being changed in such a way as to render the *Server* inoperable.

If a *Server* publishes information about the *Roles* for a *Namespace* assigned to the current *Session*, it shall add the *DefaultUserRolePermissions Property* to the *NamespaceMetadata Object* for that *Namespace*. The value of this *Property* shall be a readonly list of *Permissions* for each *Role* assigned to the current *Session*. If a particular *Node* in the *Namespace* overrides the default *RolePermissions* the *Server* shall also override the *DefaultUserRolePermissions* by adding the *UserRolePermissions Attribute* to the *Node*. If the *Server* allows the *Permissions* to be overridden for a particular *Node* but does not currently have any *Node Permissions* configured, then the *Server* shall return the value of the *DefaultUserRolePermissions Property* for the *Node Namespace*.

If a *Server* implements a vendor specific *Role Permission* model for a *Namespace*, it shall not add the *DefaultRolePermissions* or *DefaultUserRolePermissions Properties* to the *Namespace Metadata Object*.

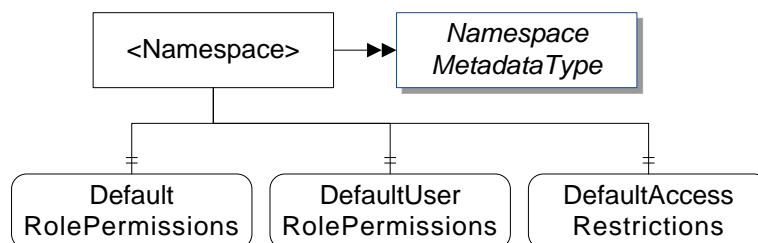

**Figure 8 – Permissions in the Address Space**

### 5.2.10 UserRolePermissions

The optional *UserRolePermissions Attribute* specifies the *Permissions* that apply to a *Node* for all *Roles* granted to current *Session*. The value of the *Attribute* is an array of *RolePermissionType Structures* (see Table 8).

*Clients* may determine their effective *Permissions* by logically ORing the *Permissions* for each *Role* in the array.

The value of this *Attribute* is derived from the rules used by the *Server* to map *Sessions* to *Roles*. This mapping may be vendor specific or it may use the standard *Role* model defined in 4.8.

This *Attribute* shall not be writeable.

If not specified, the value of *DefaultUserRolePermissions Property* from the *Namespace Metadata Object* associated with the *Node* is used instead. If the *NamespaceMetadata Object* does not define the *Property* or does not exist, then the *Server* does not publish any information about *Roles* mapped to the current *Session*.

### 5.2.11 AccessRestrictions

The optional *AccessRestrictions Attribute* specifies the *AccessRestrictions* that apply to a *Node*. Its data type is defined in 8.56. If a *Server* supports *AccessRestrictions* for a particular *Namespace* it adds the *DefaultAccessRestrictions Property* to the *NamespaceMetadata Object* for that *Namespace* (see Figure 8). If a particular *Node* in the *Namespace* needs to override the default value the *Server* adds the *AccessRestrictions Attribute* to the *Node*.

If a *Server* implements a vendor specific access restriction model for a *Namespace*, it does not add the *DefaultAccessRestrictions Property* to the *NamespaceMetadata Object*.

## 5.3 ReferenceType NodeClass

### 5.3.1 General

*References* are defined as instances of *ReferenceType Nodes*. *ReferenceType Nodes* are visible in the *AddressSpace* and are defined using the *ReferenceType NodeClass* as specified in Table 9. In contrast, a *Reference* is an inherent part of a *Node* and no *NodeClass* is used to represent *References*.

This standard defines a set of *ReferenceTypes* provided as an inherent part of the OPC UA Address Space Model. These *ReferenceTypes* are defined in Clause 7 and their representation in the *AddressSpace* is defined in OPC 10000-5. *Servers* may also define *ReferenceTypes*. In addition, OPC 10000-4 defines *NodeManagement Services* that allow *Clients* to add *ReferenceTypes* to the *AddressSpace*.

**Table 9 – ReferenceType NodeClass**

Name	Use	Data Type	Description
<b>Attributes</b>			
Base NodeClass Attributes	M	--	Inherited from the <i>Base NodeClass</i> . See 5.2.
IsAbstract	M	Boolean	A boolean <i>Attribute</i> with the following values: TRUE it is an abstract <i>ReferenceType</i> , i.e. no <i>Reference</i> of this type shall exist, only of its subtypes. FALSE it is not an abstract <i>ReferenceType</i> , i.e. <i>References</i> of this type can exist.
Symmetric	M	Boolean	A boolean <i>Attribute</i> with the following values: TRUE the meaning of the <i>ReferenceType</i> is the same as seen from both the <i>SourceNode</i> and the <i>TargetNode</i> . FALSE the meaning of the <i>ReferenceType</i> as seen from the <i>TargetNode</i> is the inverse of that as seen from the <i>SourceNode</i> .
InverseName	O	LocalizedText	The inverse name of the <i>Reference</i> , which is the meaning of the <i>ReferenceType</i> as seen from the <i>TargetNode</i> .
<b>References</b>			
HasProperty	0..*		Used to identify the <i>Properties</i> (see 5.3.3.2).
HasSubtype	0..*		Used to identify subtypes (see 5.3.3.3).
<b>Standard Properties</b>			
NodeVersion	O	String	The <i>NodeVersion Property</i> is used to indicate the version of a <i>Node</i> . The <i>NodeVersion Property</i> is updated each time a <i>Reference</i> is added or deleted to the <i>Node</i> the <i>Property</i> belongs to. <i>Attribute</i> value changes do not cause the <i>NodeVersion</i> to change. <i>Clients</i> may read the <i>NodeVersion Property</i> or subscribe to it to determine when the structure of a <i>Node</i> has changed.

**5.3.2 Attributes**

The *ReferenceType NodeClass* inherits the base *Attributes* from the *Base NodeClass* defined in 5.2. The inherited *BrowseName Attribute* is used to specify the meaning of the *ReferenceType* as seen from the *SourceNode*. For example, the *ReferenceType* with the *BrowseName* “Contains” is used in *References* that specify that the *SourceNode* contains the *TargetNode*. The inherited *DisplayName Attribute* contains a translation of the *BrowseName*.

The *BrowseName* of a *ReferenceType* shall be unique in a *Server*. It is not allowed that two different *ReferenceTypes* have the same *BrowseName*.

The *IsAbstract Attribute* indicates if the *ReferenceType* is abstract. Abstract *ReferenceTypes* cannot be instantiated and are used only for organizational reasons, for example to specify some general semantics or constraints that its subtypes inherit.

The *Symmetric Attribute* is used to indicate whether or not the meaning of the *ReferenceType* is the same for both the *SourceNode* and *TargetNode*.

If a *ReferenceType* is symmetric, the *InverseName Attribute* shall be omitted. Examples of symmetric *ReferenceTypes* are “Connects To” and “Communicates With”. Both imply the same semantic coming from the *SourceNode* or the *TargetNode*. Therefore both directions are considered to be forward *References*.

If the *ReferenceType* is non-symmetric and not abstract, the *InverseName Attribute* shall be set. The *InverseName Attribute* specifies the meaning of the *ReferenceType* as seen from the *TargetNode*. Examples of non-symmetric *ReferenceTypes* include “Contains” and “Contained In”, and “Receives From” and “Sends To”.

*References* that use the *InverseName*, such as “Contained In” *References*, are referred to as inverse *References*.

Figure 9 provides examples of symmetric and non-symmetric *References* and the use of the *BrowseName* and the *InverseName*.

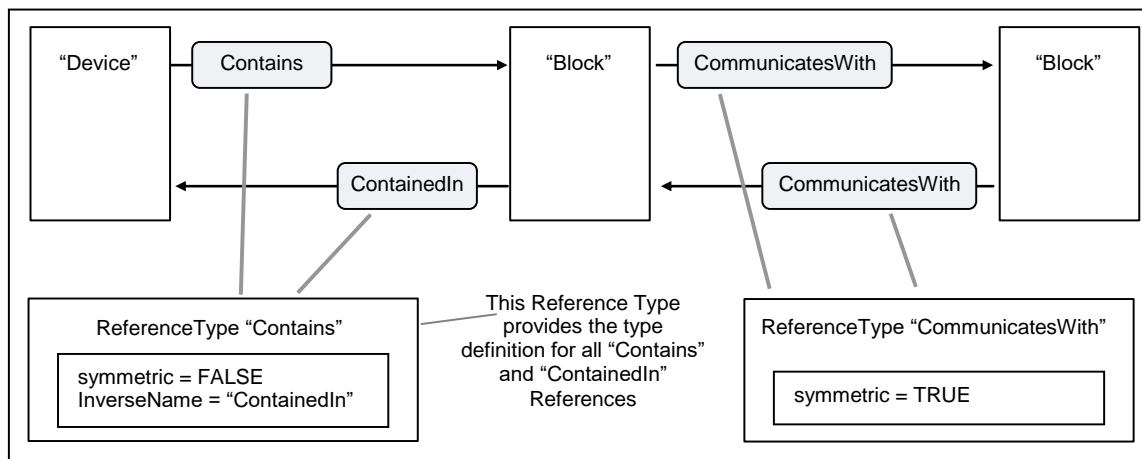

**Figure 9 – Symmetric and Non-Symmetric References**

It might not always be possible for *Servers* to instantiate both forward and inverse *References* for non-symmetric *ReferenceTypes* as shown in Figure 9. When they do, the *References* are referred to as *bidirectional*. Although not required, it is recommended that all *hierarchical References* be instantiated as bidirectional to ensure browse connectivity. A bidirectional *Reference* is modelled as two separate *References*.

As an example of a *unidirectional Reference*, it is often the case that a signal sink knows its signal source, but this signal source does not know its signal sink. The signal sink would have a “Sourced By” *Reference* to the signal source, without the signal source having the corresponding “Sourced To” inverse *References* to its signal sinks.

The *DisplayName* and the *InverseName* are the only standardised places to indicate the semantic of a *ReferenceType*. There may be more complex semantics associated with a *ReferenceType* than can be expressed in those *Attributes* (e.g. the semantic of *HasSubtype*). This standard does not specify how this semantic should be exposed. However, the *Description Attribute* can be used for this purpose. This standard provides a semantic for the *ReferenceTypes* specified in Clause 7.

A *ReferenceType* can have constraints restricting its use. For example, it can specify that starting from *Node A* and only following *References* of this *ReferenceType* or one of its subtypes, it shall never be able to return to *A*, that is, a “No Loop” constraint.

This standard does not specify how those constraints could or should be made available in the *AddressSpace*. Nevertheless, for the standard *ReferenceTypes*, some constraints are specified in Clause 7. This standard does not restrict the kind of constraints valid for a *ReferenceType*. It can, for example, also affect an *ObjectType*. The restriction that a *ReferenceType* can only be used by relating *Nodes* of some *NodeClasses* with a defined cardinality is a special constraint of a *ReferenceType*.

### 5.3.3 References

#### 5.3.3.1 General

*HasSubtype References* and *HasProperty References* are the only *ReferenceTypes* that may be used with *ReferenceType Nodes* as *SourceNode*. *ReferenceType Nodes* shall not be the *SourceNode* of other types of *References*.

#### 5.3.3.2 HasProperty References

*HasProperty References* are used to identify the *Properties* of a *ReferenceType* and shall only refer to *Nodes* of the *Variable NodeClass*.

The *Property NodeVersion* is used to indicate the version of the *ReferenceType*.

There are no additional *Properties* defined for *ReferenceTypes* in this standard. Additional parts this series of standards may define additional *Properties* for *ReferenceTypes*.

### 5.3.3.3 HasSubtype References

*HasSubtype References* are used to define subtypes of *ReferenceTypes*. It is not required to provide the *HasSubtype Reference* for the supertype, but it is required that the subtype provides the inverse *Reference* to its supertype. The following rules for subtyping apply.

- a) The semantic of a *ReferenceType* (e.g. “spans a hierarchy”) is inherited to its subtypes and can be refined there (e.g. “spans a special hierarchy”). The *DisplayName*, and also the *InverseName* for non-symmetric *ReferenceTypes*, reflect the specialization.
- b) If a *ReferenceType* specifies some constraints (e.g. “allow no loops”) this is inherited and can only be refined (e.g. inheriting “no loops” could be refined as “shall be a tree – only one parent”) but not lowered (e.g. “allow loops”).
- c) The constraints concerning which *NodeClasses* can be referenced are also inherited and can only be further restricted. That is, if a *ReferenceType* “A” is not allowed to relate an *Object* with an *ObjectType*, this is also true for its subtypes.
- d) A *ReferenceType* shall have exactly one supertype, except for the *References ReferenceType* defined in 7.2 as the root type of the *ReferenceType* hierarchy. The *ReferenceType* hierarchy does not support multiple inheritances.

## 5.4 View NodeClass

Underlying systems are often large and *Clients* often have an interest in only a specific subset of the data. They do not need, or want, to be burdened with viewing *Nodes* in the *AddressSpace* for which they have no interest.

To address this problem, this standard defines the concept of a *View*. Each *View* defines a subset of the *Nodes* in the *AddressSpace*. The entire *AddressSpace* is the default *View*. Each *Node* in a *View* may contain only a subset of its *References*, as defined by the creator of the *View*. The *View Node* acts as the root for the *Nodes* in the *View*. *Views* are defined using the *View NodeClass*, which is specified in Table 10.

All *Nodes* contained in a *View* shall be accessible starting from the *View Node* when browsing in the context of the *View*. It is not expected that all containing *Nodes* can be browsed directly from the *View Node* but rather browsed from other *Nodes* contained in the *View*.

A *View Node* may not only be used as additional entry point into the *AddressSpace* but as a construct to organize the *AddressSpace* and thus as the only entry point into a subset of the *AddressSpace*. Therefore *Clients* shall not ignore *View Nodes* when exposing the *AddressSpace*. Simple *Clients* that do not deal with *Views* for filtering purposes can, for example, handle a *View Node* like an *Object* of type *FolderType* (see 5.5.3).

Table 10 – View NodeClass

Name	Use	Data Type	Description																		
<b>Attributes</b>																					
Base NodeClass Attributes	M	--	Inherited from the <i>Base NodeClass</i> . See 5.2.																		
ContainsNoLoops	M	Boolean	If set to "true" this <i>Attribute</i> indicates that by following the <i>References</i> in the context of the <i>View</i> there are no loops, i.e. starting from a <i>Node</i> "A" contained in the <i>View</i> and following the forward <i>References</i> in the context of the <i>View Node</i> "A" will not be reached again. It does not specify that there is only one path starting from the <i>View Node</i> to reach a <i>Node</i> contained in the <i>View</i> . If set to "false" this <i>Attribute</i> indicates that following <i>References</i> in the context of the <i>View</i> may lead to loops.																		
EventNotifier	M	Byte	The <i>EventNotifier Attribute</i> is used to indicate if the <i>Node</i> can be used to subscribe to <i>Events</i> or to read / write historic <i>Events</i> . The <i>EventNotifier</i> is an 8-bit unsigned integer with the structure defined in the following table. <table border="1" data-bbox="670 739 1396 1176"> <thead> <tr> <th>Field</th> <th>Bit</th> <th>Description</th> </tr> </thead> <tbody> <tr> <td>SubscribeTo Events</td> <td>0</td> <td>Indicates if it can be used to subscribe to <i>Events</i> (0 means cannot be used to subscribe to <i>Events</i>, 1 means can be used to subscribe to <i>Events</i>)</td> </tr> <tr> <td>Reserved</td> <td>1</td> <td>Reserved for future use. Shall always be zero.</td> </tr> <tr> <td>HistoryRead</td> <td>2</td> <td>Indicates if the history of the <i>Events</i> is readable (0 means not readable, 1 means readable)</td> </tr> <tr> <td>HistoryWrite</td> <td>3</td> <td>Indicates if the history of the <i>Events</i> is writable (0 means not writable, 1 means writable)</td> </tr> <tr> <td>Reserved</td> <td>4:7</td> <td>Reserved for future use. Shall always be zero</td> </tr> </tbody> </table> <p>The second two bits also indicate if the history of the <i>Events</i> is available via the OPC UA <i>Server</i>.</p>	Field	Bit	Description	SubscribeTo Events	0	Indicates if it can be used to subscribe to <i>Events</i> (0 means cannot be used to subscribe to <i>Events</i> , 1 means can be used to subscribe to <i>Events</i> )	Reserved	1	Reserved for future use. Shall always be zero.	HistoryRead	2	Indicates if the history of the <i>Events</i> is readable (0 means not readable, 1 means readable)	HistoryWrite	3	Indicates if the history of the <i>Events</i> is writable (0 means not writable, 1 means writable)	Reserved	4:7	Reserved for future use. Shall always be zero
Field	Bit	Description																			
SubscribeTo Events	0	Indicates if it can be used to subscribe to <i>Events</i> (0 means cannot be used to subscribe to <i>Events</i> , 1 means can be used to subscribe to <i>Events</i> )																			
Reserved	1	Reserved for future use. Shall always be zero.																			
HistoryRead	2	Indicates if the history of the <i>Events</i> is readable (0 means not readable, 1 means readable)																			
HistoryWrite	3	Indicates if the history of the <i>Events</i> is writable (0 means not writable, 1 means writable)																			
Reserved	4:7	Reserved for future use. Shall always be zero																			
<b>References</b>																					
HierarchicalReferences	0..*		Top level <i>Nodes</i> in a <i>View</i> are referenced by <i>hierarchical References</i> (see 7.3).																		
HasProperty	0..*		<i>HasProperty References</i> identify the <i>Properties</i> of the <i>View</i> .																		
<b>Standard Properties</b>																					
NodeVersion	O	String	The <i>NodeVersion Property</i> is used to indicate the version of a <i>Node</i> . The <i>NodeVersion Property</i> is updated each time a <i>Reference</i> is added or deleted to the <i>Node</i> the <i>Property</i> belongs to. <i>Attribute</i> value changes do not cause the <i>NodeVersion</i> to change. <i>Clients</i> may read the <i>NodeVersion Property</i> or subscribe to it to determine when the structure of a <i>Node</i> has changed.																		
ViewVersion	O	UInt32	The version number for the <i>View</i> . When <i>Nodes</i> are added to or removed from a <i>View</i> , the value of the <i>ViewVersion Property</i> is updated. <i>Clients</i> may detect changes to the composition of a <i>View</i> using this <i>Property</i> . The value of the <i>ViewVersion</i> shall always be greater than 0.																		

The *View NodeClass* inherits the base *Attributes* from the *Base NodeClass* defined in 5.2. It also defines two additional *Attributes*.

The mandatory *ContainsNoLoops Attribute* is set to false if the *Server* is not able to identify if the *View* contains loops or not.

The mandatory *EventNotifier Attribute* identifies if the *View* can be used to subscribe to *Events* that either occur in the content of the *View* or as *ModelChangeEvents* (see 9.32) of the content of the *View* or to read / write the history of the *Events*. A *View* that supports *Events* shall provide all *Events* that occur in any *Object* used as *EventNotifier* that is part of the content of the *View*. In addition, it shall provide all *ModelChangeEvents* that occur in the context of the *View*.

To avoid recursion, i.e. getting all *Events* of the *Server*, the *Server Object* defined in OPC 10000-5 shall never be part of any *View* since it provides all *Events* of the *Server*.



*Views* are defined by the *Server*. The browsing and querying *Services* defined in OPC 10000-4 expect the *NodeId* of a *View Node* to provide these *Services* in the context of the *View*.

*HasProperty References* are used to identify the *Properties* of a *View*. The *Property NodeVersion* is used to indicate the version of the *View Node*. The *ViewVersion Property* indicates the version of the content of the *View*. In contrast to the *NodeVersion*, the *ViewVersion Property* is updated even if *Nodes* not directly referenced by the *View Node* are added to or deleted from the *View*. This *Property* is optional because it might not be possible for *Servers* to detect changes in the *View* contents. *Servers* may also generate a *ModelChangeEvent*, described in 9.32, if *Nodes* are added to or deleted from the *View*. There are no additional *Properties* defined for *Views* in this document. Additional parts of this series of standards may define additional *Properties* for *Views*.

*Views* can be the *SourceNode* of any *hierarchical Reference*. They shall not be the *SourceNode* of any *non-hierarchical Reference*.

## **5.5 Objects**

### **5.5.1 Object NodeClass**

*Objects* are used to represent systems, system components, real-world objects and software objects. *Objects* are defined using the *Object NodeClass*, specified in Table 11.

Table 11 – Object NodeClass

Name	Use	Data Type	Description
<b>Attributes</b>			
Base NodeClass Attributes	M	--	Inherited from the <i>Base NodeClass</i> . See 5.2.
EventNotifier	M	EventNotifierType	The <i>EventNotifier Attribute</i> is used to indicate if the <i>Node</i> can be used to subscribe to <i>Events</i> or the read / write historic <i>Events</i> . The <i>EventNotifierType</i> is defined in 0.
<b>References</b>			
HasComponent	0..*		<i>HasComponent References</i> identify the <i>DataVariables</i> , the <i>Methods</i> and <i>Objects</i> contained in the <i>Object</i> .
HasProperty	0..*		<i>HasProperty References</i> identify the <i>Properties</i> of the <i>Object</i> .
HasModellingRule	0..1		<i>Objects</i> can point to at most one <i>ModellingRule Object</i> using a <i>HasModellingRule Reference</i> (see 6.4.4 for details on <i>ModellingRules</i> ).
HasTypeDefinition	1		The <i>HasTypeDefinition Reference</i> points to the type definition of the <i>Object</i> . Each <i>Object</i> shall have exactly one type definition and therefore be the <i>SourceNode</i> of exactly one <i>HasTypeDefinition Reference</i> pointing to an <i>ObjectType</i> . See 4.5 for a description of type definitions.
HasEventSource	0..*		The <i>HasEventSource Reference</i> points to event sources of the <i>Object</i> . <i>References</i> of this type can only be used for <i>Objects</i> having their "SubscribeToEvents" bit set in the <i>EventNotifier Attribute</i> . See 7.17 for details.
HasNotifier	0..*		The <i>HasNotifier Reference</i> points to notifiers of the <i>Object</i> . <i>References</i> of this type can only be used for <i>Objects</i> having their "SubscribeToEvents" bit set in the <i>EventNotifier Attribute</i> . See 7.18 for details.
Organizes	0..*		This <i>Reference</i> should be used only for <i>Objects</i> of the <i>ObjectType FolderType</i> (see 5.5.3).
<other References>	0..*		<i>Objects</i> may contain other <i>References</i> .
<b>Standard Properties</b>			
NodeVersion	O	String	The <i>NodeVersion Property</i> is used to indicate the version of a <i>Node</i> . The <i>NodeVersion Property</i> is updated each time a <i>Reference</i> is added or deleted to the <i>Node</i> the <i>Property</i> belongs to. <i>Attribute</i> value changes do not cause the <i>NodeVersion</i> to change. <i>Clients</i> may read the <i>NodeVersion Property</i> or subscribe to it to determine when the structure of a <i>Node</i> has changed.
Icon	O	Image	The <i>Icon Property</i> provides an image that can be used by <i>Clients</i> when displaying the <i>Node</i> . It is expected that the <i>Icon Property</i> contains a relatively small image.
NamingRule	O	NamingRuleType	The <i>NamingRule Property</i> defines the <i>NamingRule</i> of a <i>ModellingRule</i> (see 6.4.4.2.1 for details). This <i>Property</i> shall only be used for <i>Objects</i> of the type <i>ModellingRuleType</i> defined in 6.4.4.

The *Object NodeClass* inherits the base *Attributes* from the *Base NodeClass* defined in 5.2.

The mandatory *EventNotifier Attribute* identifies whether the *Object* can be used to subscribe to *Events* or to read and write the history of the *Events*.

The *Object NodeClass* uses the *HasComponent Reference* to define the *DataVariables*, *Objects* and *Methods* of an *Object*.

It uses the *HasProperty Reference* to define the *Properties* of an *Object*. The *Property NodeVersion* is used to indicate the version of the *Object*. The *Property Icon* provides an icon of the *Object*. The *Property NamingRule* defines the *NamingRule* of a *ModellingRule* and shall only be applied to *Objects* of type *ModellingRuleType*. There are no additional *Properties* defined for *Objects* in this document. Additional parts of this series of standards may define additional *Properties* for *Objects*.

To specify its *ModellingRule*, an *Object* can use at most one *HasModellingRule Reference* pointing to a *ModellingRule Object*. *ModellingRules* are defined in 6.4.4.

*HasNotifier* and *HasEventSource References* are used to provide information about eventing and can only be applied to *Objects* used as event notifiers. Details are defined in 7.16 and 7.18.

The *HasTypeDefinition Reference* points to the *ObjectType* used as type definition of the *Object*.

*Objects* may use any additional *References* to define relationships to other *Nodes*. No restrictions are placed on the types of *References* used or on the *NodeClasses* of the *Nodes* that may be referenced. However, restrictions may be defined by the *ReferenceType* excluding its use for *Objects*. Standard *ReferenceTypes* are described in Clause 7.

If the *Object* is used as an *InstanceDeclaration* (see 4.5) then all *Nodes* referenced with forward *hierarchical References* direction shall have unique *BrowseNames* in the context of this *Object*.

If the *Object* is created based on an *InstanceDeclaration* then it shall have the same *BrowseName* as its *InstanceDeclaration*.

### 5.5.2 ObjectType NodeClass

*ObjectTypes* provide definitions for *Objects*. *ObjectTypes* are defined using the *ObjectType NodeClass*, which is specified in Table 12.

**Table 12 – ObjectType NodeClass**

Name	Use	Data Type	Description
<b>Attributes</b>			
Base NodeClass Attributes	M	--	Inherited from the <i>Base NodeClass</i> . See 5.2.
IsAbstract	M	Boolean	A boolean <i>Attribute</i> with the following values: TRUE      it is an abstract <i>ObjectType</i> , i.e. no <i>Objects</i> of this type shall exist, only <i>Objects</i> of its subtypes. FALSE     it is not an abstract <i>ObjectType</i> , i.e. <i>Objects</i> of this type can exist.
<b>References</b>			
HasComponent	0..*		<i>HasComponent References</i> identify the <i>DataVariables</i> , the <i>Methods</i> , and <i>Objects</i> contained in the <i>ObjectType</i> . If and how the referenced <i>Nodes</i> are instantiated when an <i>Object</i> of this type is instantiated, is specified in 6.4.
HasProperty	0..*		<i>HasProperty References</i> identify the <i>Properties</i> of the <i>ObjectType</i> . If and how the <i>Properties</i> are instantiated when an <i>Object</i> of this type is instantiated, is specified in 6.4.
HasSubtype	0..*		<i>HasSubtype References</i> identify <i>ObjectTypes</i> that are subtypes of this type. The inverse <i>SubtypeOf Reference</i> identifies the parent type of this type.
GeneratesEvent	0..*		<i>GeneratesEvent References</i> identify the type of <i>Events</i> instances of this type may generate.
<other References>	0..*		<i>ObjectTypes</i> may contain other <i>References</i> that can be instantiated by <i>Objects</i> defined by this <i>ObjectType</i> .
<b>Standard Properties</b>			
NodeVersion	O	String	The <i>NodeVersion Property</i> is used to indicate the version of a <i>Node</i> . The <i>NodeVersion Property</i> is updated each time a <i>Reference</i> is added or deleted to the <i>Node</i> the <i>Property</i> belongs to. <i>Attribute</i> value changes do not cause the <i>NodeVersion</i> to change. <i>Clients</i> may read the <i>NodeVersion Property</i> or subscribe to it to determine when the structure of a <i>Node</i> has changed.
Icon	O	Image	The <i>Icon Property</i> provides an image that can be used by <i>Clients</i> when displaying the <i>Node</i> . It is expected that the <i>Icon Property</i> contains a relatively small image.

The *ObjectType NodeClass* inherits the base *Attributes* from the *Base NodeClass* defined in 5.2. The additional *IsAbstract Attribute* indicates if the *ObjectType* is abstract or not.

The *ObjectType NodeClass* uses the *HasComponent References* to define the *DataVariables*, *Objects*, and *Methods* for it.

The *HasProperty Reference* is used to identify the *Properties*. The *Property NodeVersion* is used to indicate the version of the *ObjectType*. The *Property Icon* provides an icon of the *ObjectType*. There are no additional *Properties* defined for *ObjectTypes* in this document. Additional parts of this series of standards may define additional *Properties* for *ObjectTypes*.

*HasSubtype References* are used to subtype *ObjectType*s. *ObjectType* subtypes inherit the general semantics from the parent type. The general rules for subtyping apply as defined in Clause 6. It is not required to provide the *HasSubtype Reference* for the supertype, but it is required that the subtype provides the inverse *Reference* to its supertype.

*GeneratesEvent References* identify the type of *Events* that instances of the *ObjectType* may generate. These *Objects* may be the source of an *Event* of the specified type or one of its subtypes. *Servers* should make *GeneratesEvent References* bidirectional *References*. However, it is allowed to be unidirectional when the *Server* is not able to expose the inverse direction pointing from the *EventType* to each *ObjectType* supporting the *EventType*. Note that the *EventNotifier Attribute* of an *Object* and the *GeneratesEvent References* of its *ObjectType* are completely unrelated. *Objects* that can generate *Events* might not be used as *Objects* to which *Clients* subscribe to get the corresponding *Event* notifications.

*GeneratesEvent References* are optional, i.e. *Objects* may generate *Events* of an *EventType* that is not exposed by its *ObjectType*.

*ObjectTypes* may use any additional *References* to define relationships to other *Nodes*. No restrictions are placed on the types of *References* used or on the *NodeClasses* of the *Nodes* that may be referenced. However, restrictions may be defined by the *ReferenceType* excluding its use for *ObjectTypes*. Standard *ReferenceTypes* are described in Clause 7.

All *Nodes* referenced with forward *hierarchical References* shall have unique *BrowseNames* in the context of an *ObjectType* (see 4.5).

### 5.5.3 Standard ObjectType FolderType

The *ObjectType FolderType* is formally defined in OPC 10000-5. Its purpose is to provide *Objects* that have no other semantic than organizing of the *AddressSpace*. A special *ReferenceType* is introduced for those *Folder Objects*, the *Organizes ReferenceType*. The *SourceNode* of such a *Reference* should always be a *View* or an *Object* of the *ObjectType FolderType*; the *TargetNode* can be of any *NodeClass*. *Organizes References* can be used in any combination with *HasChild References* (*HasComponent*, *HasProperty*, etc.; see 7.5) and do not prevent loops. Thus, they can be used to span multiple hierarchies.

### 5.5.4 Client-side creation of Objects of an ObjectType

*Objects* are always based on an *ObjectType*, i.e. they have a *HasTypeDefinition Reference* pointing to its *ObjectType*.

*Clients* can create *Objects* using the *AddNodes Service* defined in OPC 10000-4. The *Service* requires specifying the *TypeDefinitionNode* of the *Object*. An *Object* created by the *AddNodes Service* contains all components defined by its *ObjectType* dependent on the *ModellingRules* specified for the components. However, the *Server* may add additional components and *References* to the *Object* and its components that are not defined by the *ObjectType*. This behaviour is *Server* dependent. The *ObjectType* only specifies the minimum set of components that shall exist for each *Object* of an *ObjectType*.

In addition to the *AddNodes Service* *ObjectTypes* may have a special *Method* with the *BrowseName* "Create". This *Method* is used to create an *Object* of this *ObjectType*. This *Method* may be useful for the creation of *Objects* where the semantic of the creation should differ from the default behaviour expected in the context of the *AddNodes Service*. For example, the values should directly differ from the default values or additional *Objects* should be added, etc. The input and output arguments of this *Method* depend on the *ObjectType*; the only commonality is the *BrowseName* identifying that this *Method* will create an *Object* based on the *ObjectType*. *Servers* should not provide a *Method* on an *ObjectType* with the *BrowseName* "Create" for any other purpose than creating *Objects* of the *ObjectType*.

## 5.6 Variables

### 5.6.1 General

Two types of *Variables* are defined, *Properties* and *DataVariables*. Although they differ in the way they are used as described in 4.4 and have different constraints described in the remainder

of 5.6 they use the same *NodeClass* described in 5.6.2. The constraints of *Properties* based on this *NodeClass* are defined in 5.6.3, the constraints of *DataVariables* in 5.6.4.

### 5.6.2 Variable NodeClass

*Variables* are used to represent values which may be simple or complex. *Variables* are defined by *VariableTypes*, as specified in 5.6.5.

*Variables* are always defined as *Properties* or *DataVariables* of other *Nodes* in the *AddressSpace*. They are never defined by themselves. A *Variable* is always part of at least one other *Node*, but may be related to any number of other *Nodes*. *Variables* are defined using the *Variable NodeClass*, specified in Table 13.

**Table 13 – Variable NodeClass**

Name	Use	Data Type	Description
<b>Attributes</b>			
Base NodeClass Attributes	M	--	Inherited from the <i>Base NodeClass</i> . See 5.2.
Value	M	Defined by the <i>Data Type Attribute</i>	The most recent value of the <i>Variable</i> that the <i>Server</i> has. Its data type is defined by the <i>Data Type Attribute</i> . It is the only <i>Attribute</i> that does not have a data type associated with it. This allows all <i>Variables</i> to have a value defined by the same <i>Value Attribute</i> .
DataType	M	NodeId	<i>NodeId</i> of the <i>Data Type</i> definition for the <i>Value Attribute</i> . Standard <i>Data Types</i> are defined in Clause 8.
ValueRank	M	Int32	This <i>Attribute</i> indicates whether the <i>Value Attribute</i> of the <i>Variable</i> is an array and how many dimensions the array has. It may have the following values: <i>n</i> > 1: the <i>Value</i> is an array with the specified number of dimensions. OneDimension (1): The value is an array with one dimension. OneOrMoreDimensions (0): The value is an array with one or more dimensions. Scalar (-1): The value is not an array. Any (-2): The value can be a scalar or an array with any number of dimensions. ScalarOrOneDimension (-3): The value can be a scalar or a one dimensional array. All <i>DataTypes</i> are considered to be scalar, even if they have array-like semantics like <i>ByteString</i> and <i>String</i> .
ArrayDimensions	O	UInt32[]	This <i>Attribute</i> specifies the maximum supported length of each dimension. If the maximum is unknown the value shall be 0. The number of elements shall be equal to the value of the <i>ValueRank Attribute</i> . This <i>Attribute</i> shall be null if <i>ValueRank</i> ≤ 0.  For example, if a <i>Variable</i> is defined by the following C array: Int32 myArray[346]; then this <i>Variable's Data Type</i> would point to an <i>Int32</i> and the <i>Variable's ValueRank</i> has the value 1 and the <i>ArrayDimensions</i> is an array with one entry having the value 346.  The maximum number of elements of an array transferred on the wire is 2147483647 (max <i>Int32</i> ).
AccessLevel	M	AccessLevelType	The <i>AccessLevel Attribute</i> is used to indicate how the <i>Value</i> of a <i>Variable</i> can be accessed (read/write) and if it contains current and/or historic data. The <i>AccessLevel</i> does not take any user access rights into account, i.e. although the <i>Variable</i> is writable this may be restricted to a certain user / user group. The <i>AccessLevelType</i> is defined in 8.57.
UserAccessLevel	M	AccessLevelType	The <i>UserAccessLevel Attribute</i> is used to indicate how the <i>Value</i> of a <i>Variable</i> can be accessed (read/write) and if it contains current or historic data taking user access rights into account. The <i>AccessLevelType</i> is defined in 8.57.
MinimumSamplingInterval	O	Duration	The <i>MinimumSamplingInterval Attribute</i> indicates how "current" the <i>Value</i> of the <i>Variable</i> will be kept. It specifies (in milliseconds) how fast the <i>Server</i> can reasonably sample the value for changes (see OPC 10000-4 for a detailed description of sampling interval).

Name	Use	Data Type	Description
			A <i>MinimumSamplingInterval</i> of 0 indicates that the <i>Server</i> is to monitor the item continuously. A <i>MinimumSamplingInterval</i> of -1 means indeterminate.
Historizing	M	Boolean	The <i>Historizing Attribute</i> indicates whether the <i>Server</i> is actively collecting data for the history of the <i>Variable</i> . This differs from the <i>AccessLevel Attribute</i> which identifies if the <i>Variable</i> has any historical data. A value of TRUE indicates that the <i>Server</i> is actively collecting data. A value of FALSE indicates the <i>Server</i> is not actively collecting data. Default value is FALSE.
AccessLevelEx	O	AccessLevelExType	The <i>AccessLevelEx Attribute</i> is used to indicate how the <i>Value</i> of a <i>Variable</i> can be accessed (read/write), if it contains current and/or historic data and its atomicity. The <i>AccessLevelEx</i> does not take any user access rights into account, i.e. although the <i>Variable</i> is writable this may be restricted to a certain user / user group. The <i>AccessLevelEx</i> is an extended version of the <i>AccessLevel</i> attribute and as such contains the 8 bits of the <i>AccessLevel</i> attribute as the first 8 bits. The <i>AccessLevelEx</i> is a 32-bit unsigned integer with the structure defined in the 8.58.  If this Attribute is not provided the information provided by these additional Fields is unknown.
<b>References</b>			
HasModellingRule	0..1		<i>Variables</i> can point to at most one <i>ModellingRule Object</i> using a <i>HasModellingRule Reference</i> (see 6.4.4 for details on <i>ModellingRules</i> ).
HasProperty	0..*		<i>HasProperty References</i> are used to identify the <i>Properties</i> of a <i>DataVariable</i> . <i>Properties</i> are not allowed to be the <i>SourceNode</i> of <i>HasProperty References</i> .
HasComponent	0..*		<i>HasComponent References</i> are used by complex <i>DataVariables</i> to identify their composed <i>DataVariables</i> . <i>Properties</i> are not allowed to use this <i>Reference</i> .
HasTypeDefinition	1		The <i>HasTypeDefinition Reference</i> points to the type definition of the <i>Variable</i> . Each <i>Variable</i> shall have exactly one type definition and therefore be the <i>SourceNode</i> of exactly one <i>HasTypeDefinition Reference</i> pointing to a <i>VariableType</i> . See 4.5 for a description of type definitions.
<other References>	0..*		<i>Data Variables</i> may be the <i>SourceNode</i> of any other <i>References</i> . <i>Properties</i> may only be the <i>SourceNode</i> of any <i>non-hierarchical Reference</i> .
<b>Standard Properties</b>			
NodeVersion	O	String	The <i>NodeVersion Property</i> is used to indicate the version of a <i>DataVariable</i> . It does not apply to <i>Properties</i> . The <i>NodeVersion Property</i> is updated each time a <i>Reference</i> is added or deleted to the <i>Node</i> the <i>Property</i> belongs to. <i>Attribute</i> value changes except for the <i>DataType Attribute</i> do not cause the <i>NodeVersion</i> to change. <i>Clients</i> may read the <i>NodeVersion Property</i> or subscribe to it to determine when the structure of a <i>Node</i> has changed. Although the relationship of a <i>Variable</i> to its <i>DataType</i> is not modelled using <i>References</i> , changes to the <i>DataType Attribute</i> of a <i>Variable</i> lead to an update of the <i>NodeVersion Property</i> .
LocalTime	O	TimeZone DataType	The <i>LocalTime Property</i> is only used for <i>DataVariables</i> . It does not apply to <i>Properties</i> . This <i>Property</i> is a structure containing the Offset and the DaylightSavingInOffset flag. The Offset specifies the time difference (in minutes) between the SourceTimestamp (UTC) associated with the value and the time at the location in which the value was obtained. The SourceTimestamp is defined in OPC 10000-4. If DaylightSavingInOffset is TRUE, then Standard/Daylight savings time (DST) at the originating location is in effect and Offset includes the DST correction. If FALSE then the Offset does not include DST correction and DST may or may not have been in effect.

Name	Use	Data Type	Description
AllowNulls	O	Boolean	The <i>AllowNulls Property</i> is only used for <i>DataVariables</i> . It does not apply to <i>Properties</i> . This <i>Property</i> specifies if a null value is allowed for the <i>Value Attribute</i> of the <i>DataVariable</i> . If it is set to true, the <i>Server</i> may return null values and accept writing of null values. If it is set to false, the <i>Server</i> shall never return a null value and shall reject any request writing a null value. If this <i>Property</i> is not provided, it is <i>Server-specific</i> if null values are allowed or not.
ValueAsText	O	Localized Text	It is used for <i>DataVariables</i> with a finite set of <i>LocalizedTexts</i> associated with its value. For example any <i>DataVariables</i> having an <i>Enumeration DataType</i> . This optional <i>Property</i> provides the localized text representation of the value. It can be used by <i>Clients</i> only interested in displaying the text to subscribe to the <i>Property</i> instead of the value attribute.
MaxStringLength	O	UInt32	Only used for <i>DataVariables</i> having a <i>String DataType</i> . This optional <i>Property</i> indicates the maximum number of bytes supported by the <i>DataVariable</i> .
MaxCharacters	O	UInt32	Only used for <i>DataVariables</i> having a <i>String DataType</i> . This optional <i>Property</i> indicates the maximum number of Unicode characters supported by the <i>DataVariable</i> .
MaxByteStringLength	O	UInt32	Only used for <i>DataVariables</i> having a <i>ByteString DataType</i> . This optional <i>Property</i> indicates the maximum number of bytes supported by the <i>DataVariable</i> .
MaxArrayLength	O	UInt32	Only used for <i>DataVariables</i> having its <i>ValueRank Attribute</i> not set to scalar. This optional <i>Property</i> indicates the maximum length of an array supported by the <i>DataVariable</i> . In a multidimensional array it indicates the overall length. For example, a three-dimensional array of 2 x 3 x 10 has the array length of 60. NOTE In order to expose the length of an array of bytes do not use the <i>DataType ByteString</i> but an array of the <i>DataType Byte</i> . In that case the <i>MaxArrayLength</i> applies.
EngineeringUnits	O	EU Information	Only used for <i>DataVariables</i> having a <i>Number DataType</i> . This optional <i>Property</i> indicates the engineering units for the value of the <i>DataVariable</i> (e.g. hertz or seconds). Details about the <i>Property</i> and what engineering units should be used are defined in OPC 10000-8. The <i>DataType EUInformation</i> is also defined in OPC 10000-8.

The *Variable NodeClass* inherits the base *Attributes* from the *Base NodeClass* defined in 5.2.

The *Variable NodeClass* also defines a set of *Attributes* that describe the *Variable's* Runtime value. The *Value Attribute* represents the *Variable* value. The *DataType*, *ValueRank* and *ArrayDimensions Attributes* provide the capability to describe simple and complex values.

The *AccessLevel Attribute* indicates the accessibility of the *Value* of a *Variable* not taking user access rights into account. If the OPC UA *Server* does not have the ability to get the *AccessLevel* information from the underlying system then it should state that it is readable and writable. If a read or write operation is called on the *Variable* then the *Server* should transfer this request and return the corresponding *StatusCode* even if such a request is rejected. *StatusCodes* are defined in OPC 10000-4.

The *SemanticChange* flag of the *AccessLevel Attribute* is used for *Properties* that may change and define semantic aspects of the parent *Node*. For example, the *EngineeringUnit Property* describes the semantic of a *DataVariable*, whereas the *Icon Property* does not. In this example, if the *EngineeringUnit Property* may change while the *Server* is running, the *SemanticChange* flag shall be set for it.

*Servers* that support *Event* subscriptions shall generate a *SemanticChangeEvent* whenever a *Property* with *SemanticChange* flag set changes.

If a *Variable* having a *Property* with *SemanticChange* flag set is used in a *Subscription* and the *Property* value changes, then the *SemanticsChanged* bit of the *StatusCode* shall be set as defined in OPC 10000-4. *Clients* subscribing to a *Variable* should look at the *StatusCode* to

identify if the semantic has changed and retrieve the relevant *Properties* before processing the value returned from the *Subscription*.

The *UserAccessLevel Attribute* indicates the accessibility of the *Value* of a *Variable* taking user access rights into account. If the OPC UA *Server* does not have the ability to get any user access rights related information from the underlying system then it should use the same bit mask as used in the *AccessLevel Attribute*. The *UserAccessLevel Attribute* can restrict the accessibility indicated by the *AccessLevel Attribute*, but not exceed it. *Clients* should not assume access rights based on the *UserAccessLevel Attribute*. For example it is possible that the *Server* returns an error due to some server specific change which was not reflected in the state of this *Attribute* at the time the *Client* accessed the *Variable*.

The *MinimumSamplingInterval Attribute* specifies how fast the *Server* can reasonably sample the *value* for changes. The accuracy of this value (the ability of the *Server* to attain “best case” performance) can be greatly affected by system load and other factors.

The *Historizing Attribute* indicates whether the *Server* is actively collecting data for the history of the *Variable*. See OPC 10000-11 for details on historizing *Variables*.

*Clients* may read or write *Variable* values, or monitor them for value changes, as specified in OPC 10000-4. OPC 10000-8 defines additional rules when using the *Services* for automation data.

To specify its *ModellingRule*, a *Variable* can use at most one *HasModellingRule Reference* pointing to a *ModellingRule Object*. *ModellingRules* are defined in 6.4.4.

If the *Variable* is created based on an *InstanceDeclaration* (see 4.5) it shall have the same *BrowseName* as its *InstanceDeclaration*.

The other *References* are described separately for *Properties* and *DataVariables* in the remainder of 5.6

### 5.6.3 Properties

*Properties* are used to define the characteristics of *Nodes*. *Properties* are defined using the *Variable NodeClass*, specified in Table 13. However, they restrict their use.

*Properties* are the leaf of any hierarchy; therefore they shall not be the *SourceNode* of any *hierarchical References*. This includes the *HasComponent* or *HasProperty Reference*, that is, *Properties* do not contain *Properties* and cannot expose their complex structure. However, they may be the *SourceNode* of any *non-hierarchical References*.

The *HasTypeDefinition Reference* points to the *VariableType* of the *Property*. Since *Properties* are uniquely identified by their *BrowseName*, all *Properties* shall point to the *PropertyType* defined in OPC 10000-5.

*Properties* shall always be defined in the context of another *Node* and shall be the *TargetNode* of at least one *HasProperty Reference*. To distinguish them from *DataVariables*, they shall not be the *TargetNode* of any *HasComponent Reference*. Thus, a *HasProperty Reference* pointing to a *Variable Node* defines this *Node* as a *Property*.

The *BrowseName* of a *Property* is always unique in the context of a *Node*. It is not permitted for a *Node* to refer to two *Variables* using *HasProperty References* having the same *BrowseName*.

### 5.6.4 DataVariable

*DataVariables* represent the content of an *Object*. *DataVariables* are defined using the *Variable NodeClass*, specified in Table 13.

*DataVariables* identify their *Properties* using *HasProperty References*. Complex *DataVariables* use *HasComponent References* to expose their component *DataVariables*.

The *Property NodeVersion* indicates the version of the *DataVariable*.



The *Property LocalTime* indicates the difference between the *SourceTimestamp* of the value and the standard time at the location in which the value was obtained.

The *Property AllowNulls* indicates if null values are allowed for the *Value Attribute*.

The *Property ValueAsText* provides a localized text representation for enumeration values.

The *Property MaxStringLength* indicates the maximum number of bytes of a *String* value. If a *Server* does not impose a maximum number of bytes or is not able to determine the maximum number of bytes this *Property* shall not be provided. If this *Property* is provided then the *MaxCharacters Property* shall not be provided.

The *Property MaxCharacters* indicates the maximum number of Unicode characters of a string value. If a *Server* does not impose a maximum number of Unicode characters or is not able to determine the maximum number of Unicode characters this *Property* shall not be provided. If this *Property* is provided then the *MaxStringLength Property* shall not be provided.

The *Property MaxByteStringLength* indicates the maximum number of bytes of a *ByteString* value. If a *Server* does not impose a maximum number of bytes or is not able to determine the maximum number of bytes this *Property* shall not be provided.

The *Property MaxArrayLength* indicates the maximum allowed array length of the value.

The *Property EngineeringUnits* indicates the engineering units of the value. There are no additional *Properties* defined for *DataVariables* in this part of this document. Additional parts of this series of standards may define additional *Properties* for *DataVariables*. OPC 10000-8 defines a set of *Properties* that can be used for *DataVariables*.

*DataVariables* may use additional *References* to define relationships to other *Nodes*. No restrictions are placed on the types of *References* used or on the *NodeClasses* of the *Nodes* that may be referenced. However, restrictions may be defined by the *ReferenceType* excluding its use for *DataVariables*. Standard *ReferenceTypes* are described in Clause 7.

A *DataVariable* is intended to be defined in the context of an *Object*. However, complex *DataVariables* may expose other *DataVariables*, and *ObjectTypes* and complex *VariableTypes* may also contain *DataVariables*. Therefore each *DataVariable* shall be the *TargetNode* of at least one *HasComponent Reference* coming from an *Object*, an *ObjectType*, a *DataVariable* or a *VariableType*. *DataVariables* shall not be the *TargetNode* of any *HasProperty References*. Therefore, a *HasComponent Reference* pointing to a *Variable Node* identifies it as a *DataVariable*.

The *HasTypeDefinition Reference* points to the *VariableType* used as type definition of the *DataVariable*.

If the *DataVariable* is used as *InstanceDeclaration* (see 4.5) all *Nodes* referenced with forward *hierarchical References* shall have unique *BrowseNames* in the context of this *DataVariable*.

### 5.6.5 VariableType NodeClass

*VariableTypes* are used to provide type definitions for *Variables*. *VariableTypes* are defined using the *VariableType NodeClass*, as specified in Table 14.

Table 14 – VariableType NodeClass

Name	Use	Data Type	Description
<b>Attributes</b>			
Base NodeClass Attributes	M	--	Inherited from the <i>Base NodeClass</i> . See 5.2
Value	O	Defined by the <i>Data Type attribute</i>	The default <i>Value</i> for instances of this type.
DataType	M	NodeId	<i>NodeId</i> of the data type definition for instances of this type.
ValueRank	M	Int32	This <i>Attribute</i> indicates whether the <i>Value Attribute</i> of the <i>VariableType</i> is an array and how many dimensions the array has. It may have the following values: <i>n</i> > 1: the Value is an array with the specified number of dimensions. OneDimension (1): The value is an array with one dimension. OneOrMoreDimensions (0): The value is an array with one or more dimensions. Scalar (-1): The value is not an array. Any (-2): The value can be a scalar or an array with any number of dimensions. ScalarOrOneDimension (-3): The value can be a scalar or a one dimensional array. NOTE All DataTypes are considered to be scalar, even if they have array-like semantics like ByteString and String.
ArrayDimensions	O	UInt32[]	This <i>Attribute</i> specifies the length of each dimension for an array value. The Attribute specifies the maximum supported length of each dimension. If the maximum is unknown the value is 0. The number of elements shall be equal to the value of the <i>ValueRank Attribute</i> . This <i>Attribute</i> shall be null if <i>ValueRank</i> ≤ 0. For example, if a <i>VariableType</i> is defined by the following C array: <code>Int32 myArray[346];</code> then this <i>VariableType</i> 's <i>DataType</i> would point to an Int32, the <i>VariableType</i> 's <i>ValueRank</i> has the value 1 and the <i>ArrayDimensions</i> is an array with one entry having the value 346.
IsAbstract	M	Boolean	A boolean <i>Attribute</i> with the following values: TRUE it is an abstract <i>VariableType</i> , i.e. no <i>Variable</i> of this type shall exist, only of its subtypes. FALSE it is not an abstract <i>VariableType</i> , i.e. <i>Variables</i> of this type can exist.
<b>References</b>			
HasProperty	0..*		<i>HasProperty References</i> are used to identify the <i>Properties</i> of the <i>VariableType</i> . The referenced <i>Nodes</i> may be instantiated by the instances of this type, depending on the <i>ModellingRules</i> defined in 6.4.4.
HasComponent	0..*		<i>HasComponent References</i> are used for complex <i>VariableTypes</i> to identify their containing <i>DataVariables</i> . Complex <i>VariableTypes</i> can only be used for <i>DataVariables</i> . The referenced <i>Nodes</i> may be instantiated by the instances of this type, depending on the <i>ModellingRules</i> defined in 6.4.4.
HasSubtype	0..*		<i>HasSubtype References</i> identify <i>VariableTypes</i> that are subtypes of this type. The inverse <i>subtype of Reference</i> identifies the parent type of this type.
GeneratesEvent	0..*		<i>GeneratesEvent References</i> identify the type of <i>Events</i> instances of this type may generate.
<other References>	0..*		<i>VariableTypes</i> may contain other <i>References</i> that can be instantiated by <i>Variables</i> defined by this <i>VariableType</i> . <i>ModellingRules</i> are defined in 6.4.4.
<b>Standard Properties</b>			
NodeVersion	O	String	The <i>NodeVersion Property</i> is used to indicate the version of a <i>Node</i> . The <i>NodeVersion Property</i> is updated each time a <i>Reference</i> is added or deleted to the <i>Node</i> the <i>Property</i> belongs to. <i>Attribute</i> value changes except for the <i>Data Type Attribute</i> do not cause the <i>NodeVersion</i> to change. <i>Clients</i> may read the <i>NodeVersion Property</i> or subscribe to it to determine when the structure of a <i>Node</i> has changed. Although the relationship of a <i>VariableType</i> to its <i>Data Type</i> is not modelled using <i>References</i> , changes to the <i>Data Type Attribute</i> of a <i>VariableType</i> lead to an update of the <i>NodeVersion Property</i> .

The *VariableType NodeClass* inherits the base *Attributes* from the *Base NodeClass* defined in 5.2. The *VariableType NodeClass* also defines a set of *Attributes* that describe the default or initial value of its instance *Variables*. The *Value Attribute* represents the default value. The *Data Type*, *Value Rank* and *Array Dimensions Attributes* provide the capability to describe simple and complex values. The *IsAbstract Attribute* defines if the type can be directly instantiated.

The *VariableType NodeClass* uses *HasProperty References* to define the *Properties* and *HasComponent References* to define *Data Variables*. Whether they are instantiated depends on the *Modelling Rules* defined in 6.4.4.

The *Property NodeVersion* indicates the version of the *VariableType*. There are no additional *Properties* defined for *VariableTypes* in this document. Additional parts of this series of standards may define additional *Properties* for *VariableTypes*. OPC 10000-8 defines a set of *Properties* that can be used for *VariableTypes*.

*HasSubtype References* are used to subtype *VariableTypes*. *VariableType* subtypes inherit the general semantics from the parent type. The general rules for subtyping are defined in Clause 6. It is not required to provide the *HasSubtype Reference* for the supertype, but it is required that the subtype provides the inverse *Reference* to its supertype.

*GeneratesEvent References* identify that *Variables* of the *VariableType* may be the source of an *Event* of the specified *EventType* or one of its subtypes. *Servers* should make *GeneratesEvent References* bidirectional *References*. However, it is allowed to be unidirectional when the *Server* is not able to expose the inverse direction pointing from the *EventType* to each *VariableType* supporting the *EventType*.

*GeneratesEvent References* are optional, i.e. *Variables* may generate *Events* of an *EventType* that is not exposed by its *VariableType*.

*VariableTypes* may use any additional *References* to define relationships to other *Nodes*. No restrictions are placed on the types of *References* used or on the *NodeClasses* of the *Nodes* that may be referenced. However, restrictions may be defined by the *ReferenceType* excluding its use for *VariableTypes*. Standard *ReferenceTypes* are described in Clause 7.

All *Nodes* referenced with forward *hierarchical References* shall have unique *BrowseNames* in the context of the *VariableType* (see 4.5).

### 5.6.6 Client-side creation of Variables of an VariableType

*Variables* are always based on a *VariableType*, i.e. they have a *HasTypeDefinition Reference* pointing to its *VariableType*.

*Clients* can create *Variables* using the *AddNodes Service* defined in OPC 10000-4. The *Service* requires specifying the *TypeDefinitionNode* of the *Variable*. A *Variable* created by the *AddNodes Service* contains all components defined by its *VariableType* dependent on the *Modelling Rules* specified for the components. However, the *Server* may add additional components and *References* to the *Variable* and its components that are not defined by the *VariableType*. This behaviour is *Server* dependent. The *VariableType* only specifies the minimum set of components that shall exist for each *Variable* of a *VariableType*.

## 5.7 Method NodeClass

*Methods* define callable functions. *Methods* are invoked using the *Call Service* defined in OPC 10000-4. Method invocations are not represented in the *AddressSpace*. Method invocations always run to completion and always return responses when complete. *Methods* are defined using the *Method NodeClass*, specified in Table 15.

Table 15 – Method NodeClass

Name	Use	Data Type	Description
<b>Attributes</b>			
Base NodeClass Attributes	M	--	Inherited from the <i>Base NodeClass</i> . See 5.2.
Executable	M	Boolean	The <i>Executable Attribute</i> indicates if the <i>Method</i> is currently executable ("False" means not executable, "True" means executable). The <i>Executable Attribute</i> does not take any user access rights into account, i.e. although the <i>Method</i> is executable this may be restricted to a certain user / user group.
UserExecutable	M	Boolean	The <i>UserExecutable Attribute</i> indicates if the <i>Method</i> is currently executable taking user access rights into account ("False" means not executable, "True" means executable).
<b>References</b>			
HasProperty	0..*		<i>HasProperty References</i> identify the <i>Properties</i> for the <i>Method</i> .
HasModellingRule	0..1		<i>Methods</i> can point to at most one <i>ModellingRule Object</i> using a <i>HasModellingRule Reference</i> (see 6.4.4 for details on <i>ModellingRules</i> ).
GeneratesEvent	0..*		<i>GeneratesEvent References</i> identify the type of <i>Events</i> that will be generated whenever the <i>Method</i> is called.
AlwaysGeneratesEvent	0..*		<i>AlwaysGeneratesEvent References</i> identify the type of <i>Events</i> that shall be generated whenever the <i>Method</i> is called.
<other References>	0..*		<i>Methods</i> may contain other <i>References</i> .
<b>Standard Properties</b>			
NodeVersion	O	String	The <i>NodeVersion Property</i> is used to indicate the version of a <i>Node</i> . The <i>NodeVersion Property</i> is updated each time a <i>Reference</i> is added or deleted to the <i>Node</i> the <i>Property</i> belongs to. <i>Attribute</i> value changes do not cause the <i>NodeVersion</i> to change. <i>Clients</i> may read the <i>NodeVersion Property</i> or subscribe to it to determine when the structure of a <i>Node</i> has changed.
InputArguments	O	Argument[]	The <i>InputArguments Property</i> is used to specify the arguments that shall be used by a client when calling the <i>Method</i> .
OutputArguments	O	Argument[]	The <i>OutputArguments Property</i> specifies the result returned from the <i>Method</i> call.

The *Method NodeClass* inherits the base *Attributes* from the *Base NodeClass* defined in 5.2. The *Method NodeClass* defines no additional *Attributes*.

The *Executable Attribute* indicates whether the *Method* is executable, not taking user access rights into account. If the OPC UA *Server* cannot get the *Executable* information from the underlying system, it should state that it is executable. If a *Method* is called then the *Server* should transfer this request and return the corresponding *StatusCode* even if such a request is rejected. *StatusCodes* are defined in OPC 10000-4.

The *UserExecutable Attribute* indicates whether the *Method* is executable, taking user access rights into account. If the OPC UA *Server* cannot get any user rights related information from the underlying system, it should use the same value as used in the *Executable Attribute*. The *UserExecutable Attribute* can be set to "False", even if the *Executable Attribute* is set to "True", but it shall be set to "False" if the *Executable Attribute* is set to "False". *Clients* cannot assume a *Method* can be executed based on the *UserExecutable Attribute*. It is possible that the *Server* may return an access denied error due to some *Server* specific change which was not reflected in the state of this *Attribute* at the time the *Client* accessed it.

*Properties* may be defined for *Methods* using *HasProperty References*. The *Properties InputArguments* and *OutputArguments* specify the input arguments and output arguments of the *Method*. Both contain an array of the *Data Type Argument* as specified in 8.6. An empty array or a *Property* that is not provided indicates that there are no input arguments or output arguments for the *Method*.

The *Property NodeVersion* indicates the version of the *Method*. There are no additional *Properties* defined for *Methods* in this document. Additional parts of this series of standards may define additional *Properties* for *Methods*.

To specify its *ModellingRule*, a *Method* can use at most one *HasModellingRule Reference* pointing to a *ModellingRule Object*. *ModellingRules* are defined in 6.4.4.

*GeneratesEvent References* identify that *Methods* may generate an *Event* of the specified *EventType* or one of its subtypes for every call of the *Method*. A *Server* may generate one *Event* for each referenced *EventType* when a *Method* is successfully called.

*AlwaysGeneratesEvent References* identify that *Methods* will generate an *Event* of the specified *EventType* or one of its subtypes for every call of the *Method*. A *Server* shall always generate one *Event* for each referenced *EventType* when a *Method* is successfully called.

*Servers* should make *GeneratesEvent References* bidirectional *References*. However, it is allowed to be unidirectional when the *Server* is not able to expose the inverse direction pointing from the *EventType* to each *Method* generating the *EventType*.

*GeneratesEvent References* are optional, i.e. the call of a *Method* may produce *Events* of an *EventType* that is not referenced with a *GeneratesEvent Reference* by the *Method*.

*Methods* may use additional *References* to define relationships to other *Nodes*. No restrictions are placed on the types of *References* used or on the *NodeClasses* of the *Nodes* that may be referenced. However, restrictions may be defined by the *ReferenceType* excluding its use for *Methods*. Standard *ReferenceTypes* are described in Clause 7.

A *Method* shall always be the *TargetNode* of at least one *HasComponent Reference*. The *SourceNode* of these *HasComponent References* shall be an *Object* or an *ObjectType*. If a *Method* is called then the *NodeId* of one of those *Nodes* shall be put into the Call *Service* defined in OPC 10000-4 as parameter to detect the context of the *Method* operation.

If the *Method* is used as *InstanceDeclaration* (see 4.5) all *Nodes* referenced with forward *hierarchical References* shall have unique *BrowseNames* in the context of this *Method*.

## 5.8 DataTypes

### 5.8.1 DataType Model

The *DataType Model* is used to define simple and structured data types. Data types are used to describe the structure of the *Value Attribute* of *Variables* and their *VariableTypes*. Therefore each *Variable* and *VariableType* is pointing with its *DataType Attribute* to a *Node* of the *DataType NodeClass* as shown in Figure 10.

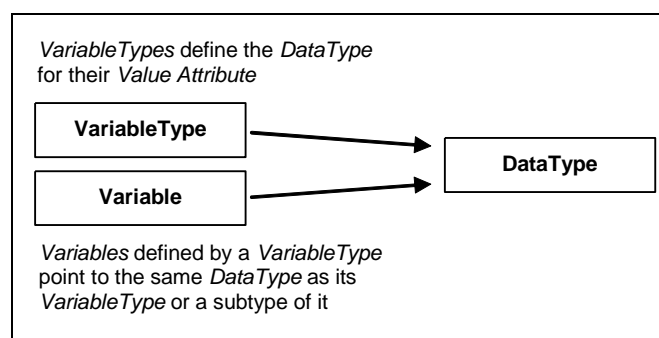
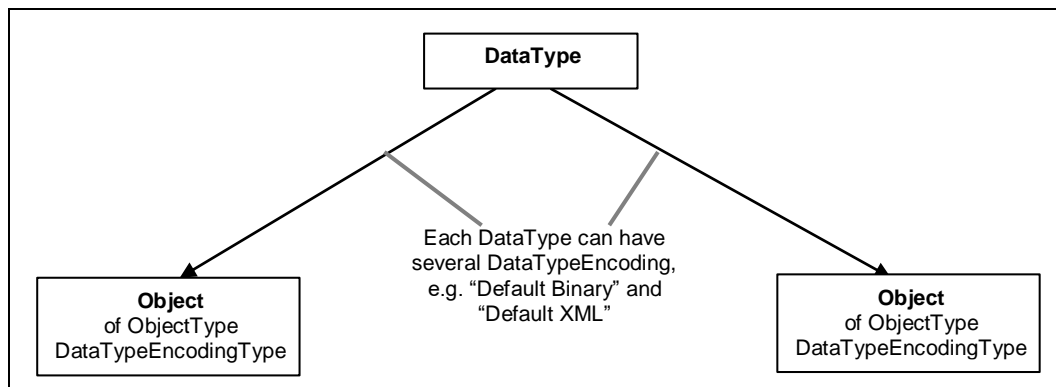

**Figure 10 – Variables, VariableTypes and their DataTypes**

In many cases, the *NodeId* of the *DataType Node* – the *DataTypeId* – will be well-known to *Clients* and *Servers*. Clause 8 defines *DataTypes* and OPC 10000-6 defines their *DataTypeIds*. In addition, other organizations may define *DataTypes* that are well-known in the industry. Well-known *DataTypeIds* provide for commonality across OPC UA *Servers* and allow *Clients* to interpret values without having to read the type description from the *Server*. Therefore, *Servers* may use well-known *DataTypeIds* without representing the corresponding *DataType Nodes* in their *AddressSpaces*.

In other cases, *DataTypes* and their corresponding *DataTypeIds* may be vendor-defined. *Servers* should attempt to expose the *DataType Nodes* and the information about the structure of those *DataTypes* for *Clients* to read, although this information might not always be available to the *Server*.

Figure 11 illustrates the *Nodes* used in the *AddressSpace* to describe the structure of a *DataType*. The *DataType* points to an *Object* of type *DataTypeEncodingType*. Each *DataType* can have several *DataTypeEncoding*, for example “Default”, “UA Binary” and “XML” encoding. Services in OPC 10000-4 allow *Clients* to request an encoding or choosing the “Default” encoding. Each *DataTypeEncoding* is used by exactly one *DataType*, that is, it is not permitted for two *DataTypes* to point to the same *DataTypeEncoding*.



**Figure 11 – DataType Model**

Since the *NodeId* of the *DataTypeEncoding* will be used in some Mappings to identify the *DataType* and it’s encoding as defined in OPC 10000-6, those *NodeIds* may also be well-known for well-known *DataTypeIds*.

### 5.8.2 Encoding Rules for different kinds of DataTypes

Different kinds of *DataTypes* are handled differently regarding their encoding and according to whether this encoding is represented in the *AddressSpace*.

*Built-in DataTypes* are a fixed set of *DataTypes* (see OPC 10000-6 for a complete list of *Built-in DataTypes*). They have no encodings visible in the *AddressSpace* since the encoding should be known to all OPC UA products. Examples of *Built-in DataTypes* are *Int32* (see 8.26) and *Double* (see 8.12).

*Simple DataTypes* are subtypes of the *Built-in DataTypes*. They are handled on the wire like the *Built-in DataType*, i.e. they cannot be distinguished on the wire from their *Built-in* supertypes. Since they are handled like *Built-in DataTypes* regarding the encoding they cannot have encodings defined in the *AddressSpace*. *Clients* can read the *DataType Attribute* of a *Variable* or *VariableType* to identify the *Simple DataType* of the *Value Attribute*. An example of a *Simple DataType* is *Duration*. It is handled on the wire as a *Double* but the *Client* can read the *DataType Attribute* and thus interpret the value as defined by *Duration* (see 8.13).

*Structured DataTypes* are *DataTypes* that represent structured data and are not defined as *Built-in DataTypes*. *Structured DataTypes* inherit directly or indirectly from the *DataType Structure* defined in 8.33. *Structured DataTypes* may have several encodings and the encodings are exposed in the *AddressSpace*. How the encoding of *Structured DataTypes* is handled on the wire is defined in OPC 10000-6. The encoding of the *Structured DataType* is transmitted with each value, thus *Clients* are aware of the *DataType* without reading the *DataType Attribute*. The encoding has to be transmitted so the *Client* is able to interpret the data. An example of a *Structured DataType* is *Argument* (see 8.6).

*Enumeration DataTypes* are *DataTypes* that represent discrete sets of named values. Enumerations are always encoded as *Int32* on the wire as defined in OPC 10000-6. *Enumeration DataTypes* inherit directly or indirectly from the *DataType Enumeration* defined in 8.14. Enumerations have no encodings exposed in the *AddressSpace*. To expose the human-readable representation of an enumerated value the *DataType Node* may have the *EnumStrings Property* that contains an array of *LocalizedText*. The Integer representation of the enumeration value points to a position within that array. *EnumValues Property* can be used instead of the *EnumStrings* to support integer representation of enumerations that are not zero-based or have gaps. It contains an array of a *Structured DataType* containing the integer representation as

well as the human-readable representation. An example of an enumeration *DataType* containing a sparse list of Integers is *NodeClass* which is defined in 8.30.

In addition to the *DataTypes* described above, abstract *DataTypes* are also supported, which do not have any encodings and cannot be exchanged on the wire. *Variables* and *VariableTypes* use abstract *DataTypes* to indicate that their *Value* may be any one of the subtypes of the abstract *DataType*. An example of an abstract *DataType* is Integer which is defined in 8.24.

### 5.8.3 **DataType NodeClass**

The *DataType NodeClass* describes the syntax of a *Variable Value*. *DataTypes* are defined using the *DataType NodeClass*, as specified in Table 16.

Table 16 – DataType NodeClass

Name	Use	Data Type	Description
<b>Attributes</b>			
Base NodeClass Attributes	M	--	Inherited from the <i>Base NodeClass</i> . See 5.2.
IsAbstract	M	Boolean	A boolean <i>Attribute</i> with the following values: TRUE it is an abstract <i>DataType</i> . FALSE it is not an abstract <i>DataType</i> .
DataTypeDefinition	O	DataTypeDefinition	The <i>DataTypeDefinition Attribute</i> is used to provide the meta data and encoding information for custom <i>DataTypes</i> . The abstract <i>DataTypeDefinition DataType</i> is defined in 8.48.  <u>Structure and Union DataTypes</u> The <i>Attribute</i> is mandatory for <i>DataTypes</i> derived from <i>Structure</i> and <i>Union</i> . For such <i>DataTypes</i> , the <i>Attribute</i> contains a structure of the <i>DataType StructureDefinition</i> . The <i>StructureDefinition DataType</i> is defined in 8.49. It is a subtype of <i>DataTypeDefinition</i> .  <u>Enumeration and OptionSet DataTypes</u> The <i>Attribute</i> is mandatory for <i>DataTypes</i> derived from <i>Enumeration</i> , <i>OptionSet</i> and subtypes of <i>UInteger</i> representing an <i>OptionSet</i> . For such <i>DataTypes</i> , the <i>Attribute</i> contains a structure of the <i>DataType EnumDefinition</i> . The <i>EnumDefinition DataType</i> is defined in 8.50. It is a subtype of <i>DataTypeDefinition</i> .
<b>References</b>			
HasProperty	0..*		<i>HasProperty References</i> identify the <i>Properties</i> for the <i>DataType</i> .
HasSubtype	0..*		<i>HasSubtype References</i> may be used to span a data type hierarchy.
HasEncoding	0..*		<i>HasEncoding References</i> identify the encodings of the <i>DataType</i> represented as <i>Objects</i> of type <i>DataTypeEncodingType</i> . Only concrete <i>Structured DataTypes</i> may use <i>HasEncoding References</i> . Abstract, <i>Built-in</i> , <i>Enumeration</i> , and <i>Simple DataTypes</i> are not allowed to be the <i>SourceNode</i> of a <i>HasEncoding Reference</i> . Each concrete <i>Structured DataType</i> shall point to at least one <i>DataTypeEncoding Object</i> with the <i>BrowseName</i> "Default Binary" or "Default XML" having the <i>NamespaceIndex</i> 0. The <i>BrowseName</i> of the <i>DataTypeEncoding Objects</i> shall be unique in the context of a <i>DataType</i> , i.e. a <i>DataType</i> shall not point to two <i>DataTypeEncodings</i> having the same <i>BrowseName</i> .
<b>Standard Properties</b>			
NodeVersion	O	String	The <i>NodeVersion Property</i> is used to indicate the version of a <i>Node</i> . The <i>NodeVersion Property</i> is updated each time a <i>Reference</i> is added or deleted to the <i>Node</i> the <i>Property</i> belongs to. <i>Attribute</i> value changes do not cause the <i>NodeVersion</i> to change. Clients may read the <i>NodeVersion Property</i> or subscribe to it to determine when the structure of a <i>Node</i> has changed. <i>Clients</i> shall not use the content for programmatic purposes except for equality comparisons.
EnumStrings	O	LocalizedText[]	The <i>EnumStrings Property</i> only applies for <i>Enumeration DataTypes</i> . It shall not be applied for other <i>DataTypes</i> . If the <i>EnumValues Property</i> is provided, the <i>EnumStrings Property</i> shall not be provided. Each entry of the array of <i>LocalizedText</i> in this <i>Property</i> represents the human-readable representation of an enumerated value. The Integer representation of the enumeration value points to a position of the array.
EnumValues	O	EnumValueType[]	The <i>EnumValues Property</i> only applies for <i>Enumeration DataTypes</i> . It shall not be applied for other <i>DataTypes</i> . If the <i>EnumStrings Property</i> is provided, the <i>EnumValues Property</i> shall not be provided. Using the <i>EnumValues Property</i> it is possible to represent Enumerations with integers that are not zero-based or have gaps (e.g. 1, 2, 4, 8, and 16). Each entry of the array of <i>EnumValueType</i> in this <i>Property</i> represents one enumeration value with its integer notation, human-readable representation and help information.
OptionSetValues	O	LocalizedText[]	The <i>OptionSetValues Property</i> only applies for <i>OptionSet DataTypes</i> and <i>UInteger DataTypes</i> . An <i>OptionSet DataType</i> is used to represent a bit mask and the <i>OptionSetValues Property</i> contains the human-readable representation for each bit of the bit mask. The <i>OptionSetValues Property</i> provides an array of <i>LocalizedText</i> containing the human-readable representation for each bit.



The *DataType NodeClass* inherits the base *Attributes* from the *Base NodeClass* defined in 5.2. The *IsAbstract Attribute* specifies if the *DataType* is abstract or not. Abstract *DataTypes* can be used in the *AddressSpace*, i.e. *Variables* and *VariableTypes* can point with their *DataType Attribute* to an abstract *DataType*. However, concrete values can never be of an abstract *DataType* and shall always be of a concrete subtype of the abstract *DataType*.

*HasProperty References* are used to identify the *Properties* of a *DataType*. The *Property NodeVersion* is used to indicate the version of the *DataType*. The *Property EnumStrings* contains human-readable representations of enumeration values and is only applied to *Enumeration DataTypes*. Instead of the *EnumStrings Property* an *Enumeration DataType* can also use the *EnumValues Property* to represent *Enumerations* with integer values that are not zero-based or containing gaps. There are no additional *Properties* defined for *DataTypes* in this standard. Additional parts of this series of standards may define additional *Properties* for *DataTypes*.

*HasSubtype References* may be used to expose a data type hierarchy in the *AddressSpace*. The semantic of subtyping is only defined to the point, that a *Server* may provide instances of the subtype instead of the *DataType*. *Clients* should not make any assumptions about any other semantic with that information. For example, it might not be possible to cast a value of one data type to its base data type. *Servers* need not provide *HasSubtype References*, even if their *DataTypes* span a type hierarchy. Some restrictions apply for subtyping enumeration *DataTypes* as defined in 8.14.

*HasEncoding References* point from the *DataType* to its *DataTypeEncodings*. Each concrete *Structured DataType* can point to many *DataTypeEncodings*, but each *DataTypeEncoding* shall belong to one *DataType*, that is, it is not permitted for two *DataType Nodes* to point to the same *DataTypeEncoding Object* using *HasEncoding References*.

An abstract *DataType* is not the *SourceNode* of a *HasEncoding Reference*. The *DataTypeEncoding* of an abstract *DataType* is provided by its concrete subtypes.

*DataType Nodes* shall not be the *SourceNode* of other types of *References*. However, they may be the *TargetNode* of other *References*.

#### 5.8.4 DataTypeEncoding and Encoding Information

If a *DataType Node* is exposed in the *AddressSpace*, it shall provide its *DataTypeEncodings* using *HasEncoding References*. These *References* shall be bi-directional. Figure 12 provides an example how *DataTypes* are modelled in the *AddressSpace*.

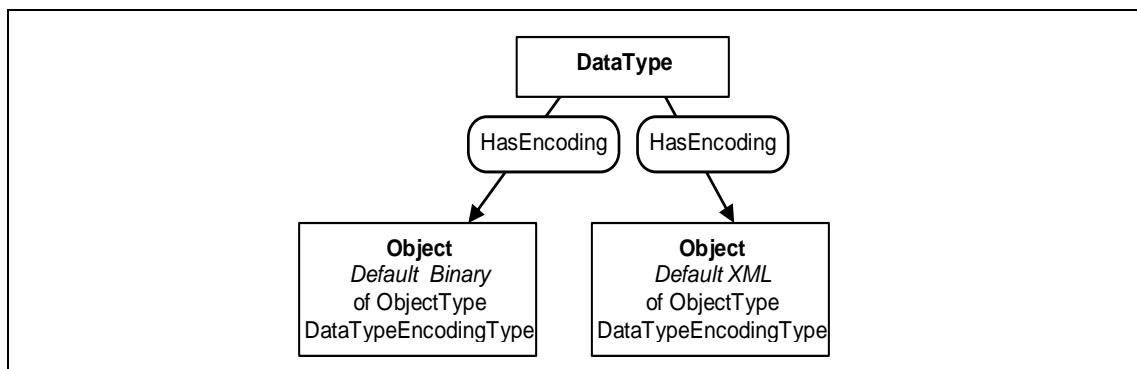

Figure 12 – Example of DataType Modelling

The information on how to encode the *DataType* is provided in the *Attribute DataTypeDefinition* of the *DataType Node*. The content of this *Attribute* shall not be changed once it had been provided to *Clients* since *Clients* might persistently cache this information. If the encoding of a *DataType* needs to be changed conceptually a new *DataType* needs to be provided, meaning that a new *NodeId* shall be used for the *DataType*. Since *Clients* identify the *DataType* via the *DataTypeEncodings*, also the *NodeIds* for the *DataTypeEncodings* of the *DataType* shall be changed, when the encoding changes.

## 5.9 Summary of Attributes of the NodeClasses

Table 17 summarises all *Attributes* defined in this document and points out which *NodeClasses* use them either in an optional (O) or mandatory (M) way.

**Table 17 – Overview of Attributes**

Attribute	Variable	Variable Type	Object	Object Type	Reference Type	Data Type	Method	View
AccessLevel	M							
AccessLevelEx	O							
ArrayDimensions	O	O						
AccessRestrictions	O	O	O	O	O	O	O	O
BrowseName	M	M	M	M	M	M	M	M
ContainsNoLoops								M
Data Type	M	M						
Data Type Definition						O		
Description	O	O	O	O	O	O	O	O
DisplayName	M	M	M	M	M	M	M	M
EventNotifier			M					M
Executable							M	
Historizing	M							
InverseName					O			
IsAbstract		M		M	M	M		
MinimumSamplingInterval	O							
NodeClass	M	M	M	M	M	M	M	M
NodeId	M	M	M	M	M	M	M	M
RolePermissions	O	O	O	O	O	O	O	O
Symmetric					M			
UserAccessLevel	M							
UserExecutable							M	
UserRolePermissions	O	O	O	O	O	O	O	O
UserWriteMask	O	O	O	O	O	O	O	O
Value	M	O						
ValueRank	M	M						
WriteMask	O	O	O	O	O	O	O	O

## 6 Type Model for ObjectTypes and VariableTypes

### 6.1 Overview

In the remainder of 6 the type model of *ObjectTypes* and *VariableTypes* is defined regarding subtyping and instantiation.

### 6.2 Definitions

#### 6.2.1 InstanceDeclaration

An *InstanceDeclaration* is an *Object*, *Variable* or *Method* that references a *ModellingRule* with a *HasModellingRule Reference* and is the *TargetNode* of a *hierarchical Reference* from a *TypeDefinitionNode* or another *InstanceDeclaration*. The type of an *InstanceDeclaration* may be abstract, however the instance must be of a concrete type.

#### 6.2.2 Instances without ModellingRules

If no *ModellingRule* exists then the *Node* is neither considered for instantiation of a type nor for subtyping.

If a *Node* referenced by a *TypeDefinitionNode* does not reference a *ModellingRule* it indicates that this *Node* only belongs to the *TypeDefinitionNode* and not to the instances. For example, an *ObjectType Node* may contain a *Property* that describes scenarios where the type could be used. This *Property* would not be considered when creating instances of the type. This is also true for subtyping, that is, subtypes of the type definition would not inherit the referenced *Node*.

### 6.2.3 InstanceDeclarationHierarchy

The *InstanceDeclarationHierarchy* of a *TypeDefinitionNode* contains the *TypeDefinitionNode* and all *InstanceDeclarations* that are directly or indirectly referenced from the *TypeDefinitionNode* using forward *hierarchical References*.

### 6.2.4 Similar Node of InstanceDeclaration

A similar *Node* of an *InstanceDeclaration* is a *Node* that has the same *BrowseName* and *NodeClass* as the *InstanceDeclaration* and in cases of *Variables* and *Objects* the same *TypeDefinitionNode* or a subtype of it.

### 6.2.5 BrowsePath

All targets of forward *hierarchical References* from a *TypeDefinitionNode* shall have a *BrowseName* that is unique within the *TypeDefinitionNode*. The same restriction applies to the targets of forward *hierarchical References* from any *InstanceDeclaration*. This means that any *InstanceDeclaration* within the *InstanceDeclarationHierarchy* can be uniquely identified by a sequence of *BrowseNames*. This sequence of *BrowseNames* is called a *BrowsePath*.

### 6.2.6 Attribute Handling of InstanceDeclarations

Some restrictions exist regarding the *Attributes* of *InstanceDeclarations* when the *InstanceDeclaration* is overridden or instantiated. The *BrowseName* and the *NodeClass* shall never change and always be the same as the original *InstanceDeclaration*.

In addition, the rules defined in 6.2.7 apply for *InstanceDeclarations* of the *NodeClass Variable*.

### 6.2.7 Attribute Handling of Variable and VariableTypes

Some restrictions exist regarding the *Attributes* of a *VariableType* or a *Variable* used as an *InstanceDeclaration* with regard to the data type of the *Value Attribute*.

When a *Variable* used as *InstanceDeclaration* or a *VariableType* is overridden or instantiated the following rules apply:

- a) The *DataType Attribute* can only be changed to a new *DataType* if the new *DataType* is a subtype of the *DataType* originally used.
- b) The *ValueRank Attribute* may only be further restricted
  - 1) 'Any' may be set to any other value;
  - 2) 'ScalarOrOneDimension' may be set to 'Scalar' or 'OneDimension';
  - 3) 'OneOrMoreDimensions' may be set to a concrete number of dimensions (value > 0).
  - 4) All other values of this *Attribute* shall not be changed.
- c) The *ArrayDimensions Attribute* may be added if it was not provided or when modifying the value of an entry in the array from 0 to a different value. All other values in the array shall remain the same.

### 6.2.8 NodeIds of InstanceDeclarations

*InstanceDeclarations* are identified by their *BrowsePath*. Different *Servers* might use different *NodeIds* for the *InstanceDeclarations* of common *TypeDefinitionNodes*, unless the definition of the *TypeDefinitionNode* already defines a *NodeId* for the *InstanceDeclaration*. All *TypeDefinitionNodes* defined in OPC 10000-5 already define the *NodeIds* for their *InstanceDeclarations* and therefore shall be used in all *Servers*.

## 6.3 Subtyping of ObjectTypes and VariableTypes

### 6.3.1 Overview

The *HasSubtype ReferenceType* defines subtypes of types. Subtyping can only occur between *Nodes* of the same *NodeClass*. Rules for subtyping *ReferenceTypes* are described in 5.3.3.3. There is no common definition for subtyping *DataTypes*, as described in 5.8.3. The remainder of 6.3 specify subtyping rules for single inheritance on *ObjectTypes* and *VariableTypes*.

### 6.3.2 Attributes

Subtypes inherit the parent type’s *Attribute* values, except for the *NodeId*. Inherited *Attribute* values may be overridden by the subtype, the *BrowseName* and *DisplayName* values should be overridden. Special rules apply for some *Attributes* of *VariableTypes* as defined in 6.2.7. Optional *Attributes*, not provided by the parent type, may be added to the subtype.

### 6.3.3 InstanceDeclarations

#### 6.3.3.1 Overview

Subtypes inherit the fully-inherited parent type’s *InstanceDeclarations*.

As long as those *InstanceDeclarations* are not overridden they are not referenced by the subtype. *InstanceDeclarations* can be overridden by adding *References*, changing *References* to reference different *Nodes*, changing *References* to be subtypes of the original *ReferenceType*, changing values of the *Attributes* or adding optional *Attributes*. In order to get the full information about a subtype, the inherited *InstanceDeclarations* have to be collected from all types that can be found by recursively following the inverse *HasSubtype References* from the subtype. This collection of *InstanceDeclarations* is called the fully-inherited *InstanceDeclarationHierarchy* of a subtype.

The remainder of 6.3.3 define how to construct the fully-inherited *InstanceDeclarationHierarchy* and how *InstanceDeclarations* can be overridden.

#### 6.3.3.2 Fully-inherited InstanceDeclarationHierarchy

An instance of a *TypeDefinitionNode* is described by the fully-inherited *InstanceDeclarationHierarchy* of the *TypeDefinitionNode*. The fully-inherited *InstanceDeclarationHierarchy* can be created by starting with the *InstanceDeclarationHierarchy* of the *TypeDefinitionNode* and merging the fully-inherited *InstanceDeclarationHierarchy* of its parent type.

The process of merging *InstanceDeclarationHierarchies* is straightforward and can be illustrated with the example shown in Figure 13 which specifies a *TypeDefinitionNode* “BetaType” which is a subtype of “AlphaType”. The name in each box is the *BrowseName* and the number is the *NodeId*.

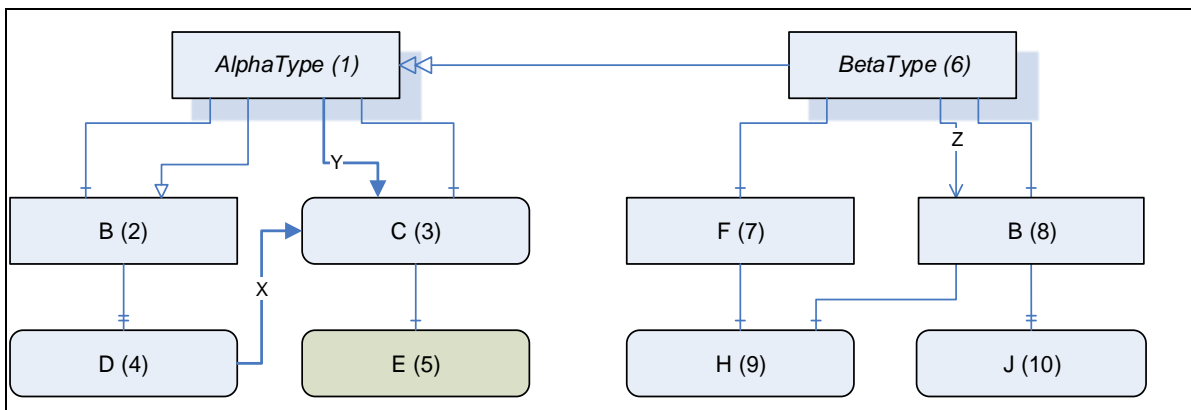

Figure 13 – Subtyping TypeDefinitionNodes

An *InstanceDeclarationHierarchy* can be fully described as a table of *Nodes* identified by their *BrowsePaths* with a corresponding table of *References*. The *InstanceDeclarationHierarchy* for “BetaType” is described in Table 18 where the top half of the table is the table of *Nodes* and the bottom half is the table of *References* (the *HasModellingRule* references have been omitted from the table for the sake of clarity; all *Nodes* except for 1, 6, and 5 have *ModellingRules*). All *InstanceDeclarations* of the *InstanceDeclarationHierarchy* and all *Nodes* referenced with a non-hierarchical *Reference* from such an *InstanceDeclaration* are added to the table. *Hierarchical References* to *Nodes* without a *ModellingRule* are not considered.

**Table 18 – The InstanceDeclarationHierarchy for BetaType**

BrowsePath	NodeId
/	6
/F	7
/B	8
/F/H	9
/B/J	10
/B/H	9

Source Path	ReferenceType	Target Path	TargetNodeId
/	HasComponent	/F	-
/	HasComponent	/B	-
/	Z	/B	-
/	HasTypeDefinition	-	BetaType
/F	HasComponent	/F/H	-
/F	HasTypeDefinition	-	BaseObjectType
/B	HasProperty	/B/J	-
/B	HasTypeDefinition	-	BaseObjectType
/F/H	HasTypeDefinition	-	PropertyType
/B/J	HasTypeDefinition	-	PropertyType
/B	HasComponent	/B/H	-
/B/H	HasTypeDefinition	-	BaseDataVariableType

Multiple *BrowsePaths* to the same *Node* shall be treated as separate *Nodes*. An *Instance* may provide different *Nodes* for each *BrowsePath*.

The fully-inherited *InstanceDeclarationHierarchy* for “BetaType” can now be constructed by merging the *InstanceDeclarationHierarchy* for “AlphaType”. The result is shown in Table 19 where the entries added from “AlphaType” are shaded with grey.

**Table 19 – The Fully-Inherited InstanceDeclarationHierarchy for BetaType**

BrowsePath	NodeId
/	6
/F	7
/B	8
/F/H	9
/B/J	10
/B/H	9
/B/D	4
/C	3

Source Path	ReferenceType	Target Path	TargetNodeId
/	HasComponent	/F	-
/	HasComponent	/B	-
/	Z	/B	-
/	HasTypeDefinition	-	BetaType
/F	HasComponent	/F/H	-
/F	HasTypeDefinition	-	BaseObjectType
/B	HasProperty	/B/J	-
/B	HasTypeDefinition	-	BaseObjectType
/F/H	HasTypeDefinition	-	PropertyType
/B/J	HasTypeDefinition	-	PropertyType
/B	HasComponent	/B/H	-
/B/H	HasTypeDefinition	-	BaseDataVariableType
/	HasNotifier	/B	-
/B	HasProperty	/B/D	-
/	HasComponent	/C	-
/	Y	/C	-
/C	HasTypeDefinition	-	BaseDataVariableType
/B/D	HasTypeDefinition	-	PropertyType
/B/D	X	/C	-

The *BrowsePath* “/B” already exists in the table so it does not need to be added. However, the *HasNotifier* reference from “/” to “/B” does not exist and was added.

The *Nodes* and *References* defined in Table 19 can be used to create the fully-inherited *InstanceDeclarationHierarchy* shown in Figure 14. The fully-inherited *InstanceDeclarationHierarchy* contains all necessary information about a *TypeDefinitionNode* regarding its complex structure without needing any additional information from its supertypes.

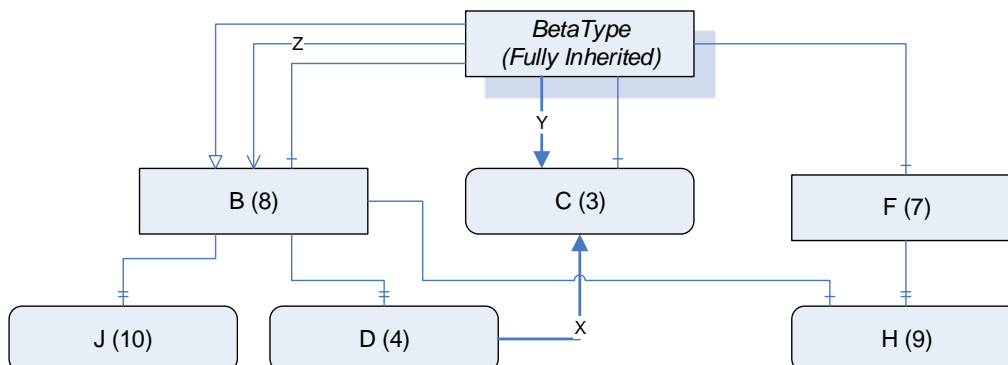

**Figure 14 – The Fully-Inherited InstanceDeclarationHierarchy for BetaType**

### 6.3.3.3 Overriding InstanceDeclarations

A subtype overrides an *InstanceDeclaration* by specifying an *InstanceDeclaration* with the same *BrowsePath*. An overridden *InstanceDeclaration* shall have the same *NodeClass* and *BrowseName*. The *TypeDefinitionNode* of the overridden *InstanceDeclaration* shall be the same or a subtype of the *TypeDefinitionNode* specified in the supertype.

When overriding an *InstanceDeclaration* it is necessary to provide *hierarchical References* that link the new *Node* back to the subtype (the *References* are used to determine the *BrowsePath* of the *Node*).

It is only possible to override *InstanceDeclarations* that are directly referenced from the *TypeDefinitionNode*. If an indirect referenced *InstanceDeclaration*, such as “J” in Figure 14, has to be overridden, then the directly referenced *InstanceDeclarations* that includes “J”, in that case “B”, have to be overridden first and then “J” can be overridden in a second step.

A *Reference* is replaced if it goes between two overridden *Nodes* and has the same *ReferenceType* as a *Reference* defined in the supertype. The *Reference* specified in the subtype may be a subtype of the *ReferenceType* used in the parent type.

Any *non-hierarchical References* specified for the overridden *InstanceDeclaration* are treated as new *References* unless the *ReferenceType* only allows a single *Reference* per *SourceNode*. If this situation exists the subtype can change the target of the *Reference* but the new target shall have the same *NodeClass* and for *Objects* and *Variables* also the same type or a subtype of the type specified in the parent.

The overriding *Node* may specify new values for the *Node Attributes* other than the *NodeClass* or *BrowseName*, however, the restrictions on *Attributes* specified in 6.2.6 apply. Any *Attribute* provided by the overridden *InstanceDeclaration* has to be provided by the overriding *InstanceDeclaration*, additional optional *Attributes* may be added.

The *ModellingRule* of the overriding *InstanceDeclaration* may be changed as defined in 6.4.4.3.

Each overriding *InstanceDeclaration* needs its own *HasModellingRule* and *HasTypeDefinition References*, even if they have not been changed.

A subtype should not override a *Node* unless it needs to change it.

The semantics of certain *TypeDefinitionNodes* and *ReferenceTypes* may impose additional restrictions with regard to overriding *Nodes*.

## 6.4 Instances of ObjectTypes and VariableTypes

### 6.4.1 Overview

Any *Instance* of a *TypeDefinitionNode* will be the root of a hierarchy which mirrors the *InstanceDeclarationHierarchy* for the *TypeDefinitionNode*. Each *Node* in the hierarchy of the *Instance* will have a *BrowsePath* which may be the same as the *BrowsePath* for one of the *InstanceDeclarations* in the hierarchy of the *TypeDefinitionNode*. The *InstanceDeclaration* with the same *BrowsePath* is called the *InstanceDeclaration* for the *Node*. If a *Node* has an *InstanceDeclaration* then it shall have the same *BrowseName* and *NodeClass* as the *InstanceDeclaration* and, in cases of *Variables* and *Objects*, the same *TypeDefinitionNode* or a subtype of it.

Instances may reference several *Nodes* with the same *BrowsePath*. *Clients* that need to distinguish between the *Nodes* based on the *InstanceDeclarationHierarchy* and the *Nodes* that are not based on the *InstanceDeclarationHierarchy* can accomplish this using the *TranslateBrowsePathsToNodeIds* service defined in OPC 10000-4.

### 6.4.2 Creating an Instance

Instances inherit the initial values for the *Attributes* that they have in common with the *TypeDefinitionNode* from which they are instantiated, with the exceptions of the *NodeClass* and *NodeId*.

When a *Server* creates an instance of a *TypeDefinitionNode* it shall create the same hierarchy of *Nodes* beneath the new *Object* or *Variable* depending on the *ModellingRule* of each *InstanceDeclaration*. Standard *ModellingRules* are defined in 6.4.4.5. The *Nodes* within the newly created hierarchy may be copies of the *InstanceDeclarations*, the *InstanceDeclaration* itself or another *Node* in the *AddressSpace* that has the same *TypeDefinitionNode* and *BrowseName*. If new copies are created, then the *Attribute* values of the *InstanceDeclarations* are used as the initial values.

Figure 15 provides a simple example of a *TypeDefinitionNode* and an *Instance*. *Nodes* referenced by the *TypeDefinitionNode* without a *ModellingRule* do not appear in the instance. *Instances* may have children with duplicate *BrowseNames*; however, only one of those children will correspond to the *InstanceDeclaration*.

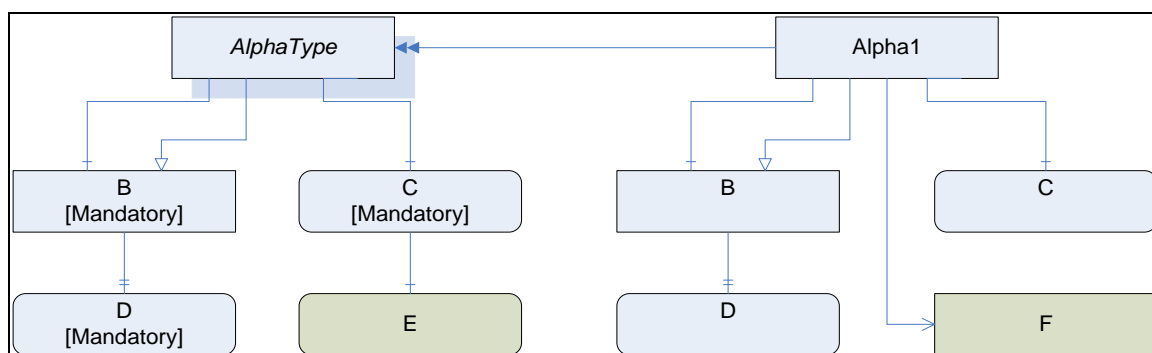

Figure 15 – An Instance and its TypeDefinitionNode

It is up to the *Server* to decide which *InstanceDeclarations* appear in any single instance. In some cases, the *Server* will not define the entire instance and will provide remote references to *Nodes* in another *Server*. The *ModellingRules* described in 6.4.4.5 allow *Servers* to indicate that some *Nodes* are always present; however, the *Client* shall be prepared for the case where the *Node* exists in a different *Server*.

A *Client* can use the information of *TypeDefinitionNodes* to access *Nodes* which are in the hierarchy of the instance. It shall pass the *NodeId* of the instance and the *BrowsePath* of the child *Nodes* based on the *TypeDefinitionNode* to the *TranslateBrowsePathsToNodeIds* service (see OPC 10000-4). This *Service* returns the *NodeId* for each of the child *Nodes*. If a child *Node* exists then the *BrowseName* and *NodeClass* shall match the *InstanceDeclaration*. In the case

of *Objects* or *Variables*, also the *TypeDefinitionNode* shall either match or be a subtype of the original *TypeDefinitionNode*.

### 6.4.3 Constraints on an Instance

*Objects* and *Variables* may change their *Attribute* values after being created. Special rules apply for some *Attributes* as defined in 6.2.6.

Additional *References* may be added to the *Nodes*, and *References* may be deleted as long as the *ModellingRules* defined on the *InstanceDeclarations* of the *TypeDefinitionNode* are still fulfilled.

For *Variables* and *Objects* the *HasTypeDefinition Reference* shall always point to the same *TypeDefinitionNode* as the *InstanceDeclaration* or a subtype of it.

If two *InstanceDeclarations* of the fully-inherited *InstanceDeclarationHierarchy* have been connected directly with several *References*, all those *References* shall connect the same *Nodes*. An example is given in Figure 16. The instances A1 and A2 are allowed since B1 references the same *Node* with both *References*, whereas A3 is not allowed since two different *Nodes* are referenced. Note that this restriction only applies for directly connected *Nodes*. For example, A2 references a C1 directly and a different C1 via B1.

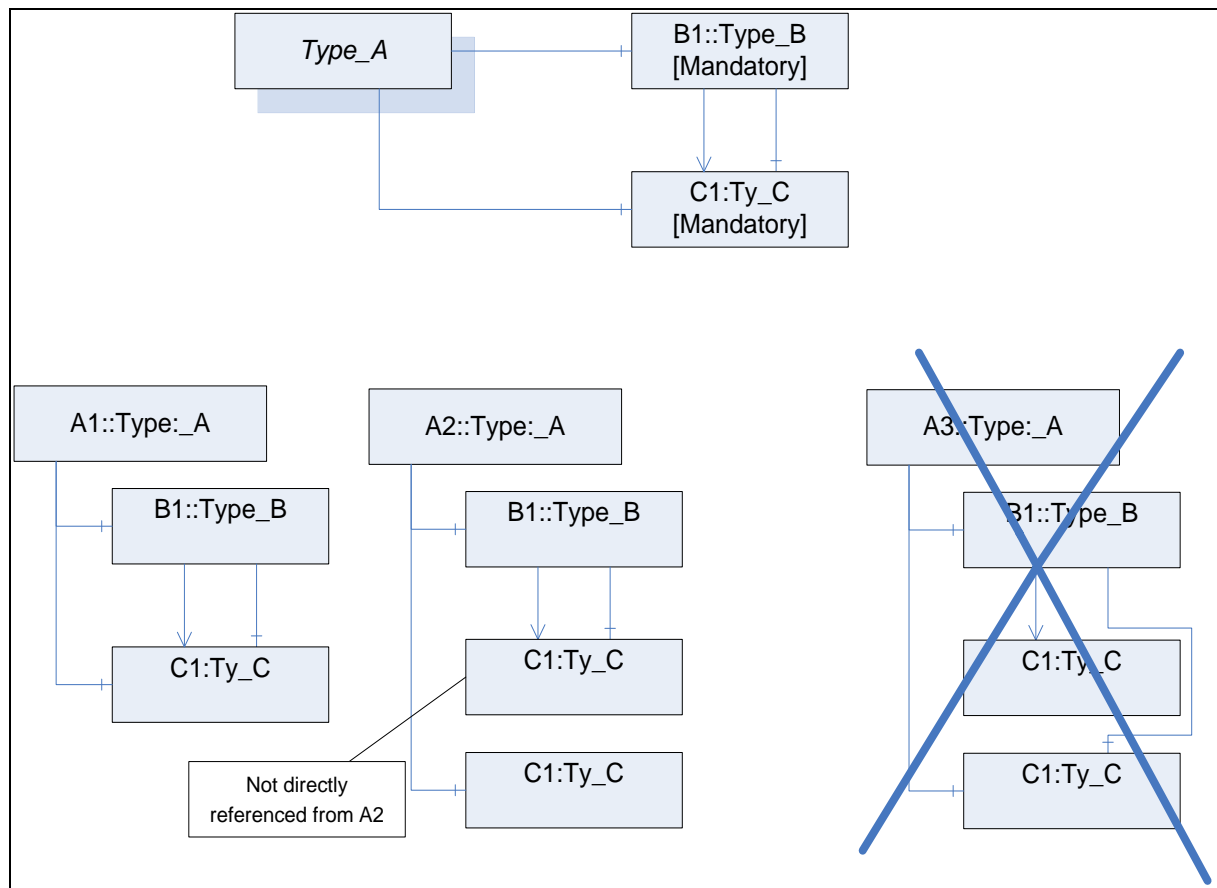

Figure 16 – Example for several References between InstanceDeclarations

### 6.4.4 ModellingRules

#### 6.4.4.1 General

For a definition of *ModellingRules*, see 6.4.4.5. Other parts of this series of standards may define additional *ModellingRules*. *ModellingRules* are an extendable concept in OPC UA; therefore vendors may define their own *ModellingRules*.

Note that the *ModellingRules* defined in this standard do not define how to deal with non-hierarchical *References* between *InstanceDeclarations*, i.e. it is *Server-specific* if those



*References* exist in an instance hierarchy or not. Other *ModellingRules* may define behaviour for non-hierarchical *References* between *InstanceDeclaration* as well.

*ModellingRules* are represented in the *AddressSpace* as *Objects* of the *ObjectType ModellingRuleType*. There are some *Properties* defining common semantic of *ModellingRules*. This edition of this standard only specifies one *Property* for *ModellingRules*. Future editions may define additional *Properties* for *ModellingRules*. OPC 10000-5 specifies the representation of the *ModellingRule Objects*, their *Properties* and their type in the *AddressSpace*. The semantic of the *Properties* for *ModellingRules* is defined in 6.4.4.2.

Subclause 6.4.4.4 defines how the *ModellingRule* may be changed when instantiating *InstanceDeclarations* with respect to the *Properties*. Subclause 6.4.4.3 defines how the *ModellingRule* may be changed when overriding *InstanceDeclarations* in subtypes with respect to the *Properties*.

**6.4.4.2 Properties describing ModellingRules**

**6.4.4.2.1 NamingRule**

*NamingRule* is a mandatory *Property* of a *ModellingRule*. It specifies the purpose of an *InstanceDeclaration*. Each *InstanceDeclaration* references a *ModellingRule* and thus the *NamingRule* is defined per *InstanceDeclaration*.

Three values are allowed for the *NamingRule* of a *ModellingRule*: *Optional*, *Mandatory*, and *Constraint*.

The following semantic is valid for the entire life-time of an instance that is based on a *TypeDefinitionNode* having an *InstanceDeclaration*.

For an instance A1 of a *TypeDefinitionNode* AlphaType with an *InstanceDeclaration* B1 having a *ModellingRule* using the *NamingRule Optional* the following rule applies: For each *BrowsePath* from AlphaType to B1 the instance A1 may or may not have a *similar Node* (see 6.2.4) for B1 with the same *BrowsePath*. If such a *Node* exists then the *TranslateBrowsePathsToNodeIds Service* (see OPC 10000-4) returns this *Node* as the first entry in the list.

For an instance A1 of a *TypeDefinitionNode* AlphaType with an *InstanceDeclaration* B1 having a *ModellingRule* using the *NamingRule Mandatory* the following rule applies: For each *BrowsePath* from AlphaType to B1 the instance A1 shall have a *similar Node* (see 6.2.4) for B1 using the same *BrowsePath* if all *Nodes* of the *BrowsePath* exist. For example, if a *Node* in the *BrowsePath* has a *NamingRule Optional* and is omitted in the instance, then all children of this *Node* would also be omitted, independent of their *ModellingRules*.

If an *InstanceDeclaration* has a *ModellingRule* using the *NamingRule Constraint* it identifies that the *BrowseName* of the *InstanceDeclaration* is of no significance but other semantic is defined with the *ModellingRule*. The *TranslateBrowsePathsToNodeIds Service* (see OPC 10000-4) can typically not be used to access instances based on those *InstanceDeclarations*.

**6.4.4.3 Subtyping Rules for Properties of ModellingRules**

It is allowed that subtypes override *ModellingRules* on their *InstanceDeclarations*. As a general rule for subtyping, constraints shall only be tightened, not loosened. Therefore, it is not allowed to specify on the supertype that an instance shall exist with the name (*NamingRule Mandatory*) and on the subtype make this optional (*NamingRule Optional*). Table 20 specifies the allowed changes on the *Properties* when exchanging the *ModellingRules* in the subtype.

**Table 20 – Rule for ModellingRules Properties when Subtyping**

	Value on supertype	Value on subtype
NamingRule	Mandatory	Mandatory
NamingRule	Optional	Mandatory or Optional
NamingRule	Constraint	Constraint

#### 6.4.4.4 Instantiation Rules for Properties of ModellingRules

There are two different use cases when creating an instance 'A' based on a *TypeDefinitionNode* 'A\_Type'. Either 'A' is used as normal instance or it is used as *InstanceDeclaration* of another *TypeDefinitionNode*.

In the first case, it is not required that newly created or referenced instances based on *InstanceDeclarations* have a *ModellingRule*, however, it is allowed that they have any *ModellingRule* independent of the *ModellingRule* of their *InstanceDeclaration*.

In Figure 17 an example is given. The instances A1, A2, and A3 are all valid instances of Type\_A, although B of A1 has no *ModellingRule* and B of A3 has a different *ModellingRule* than B of Type\_A.

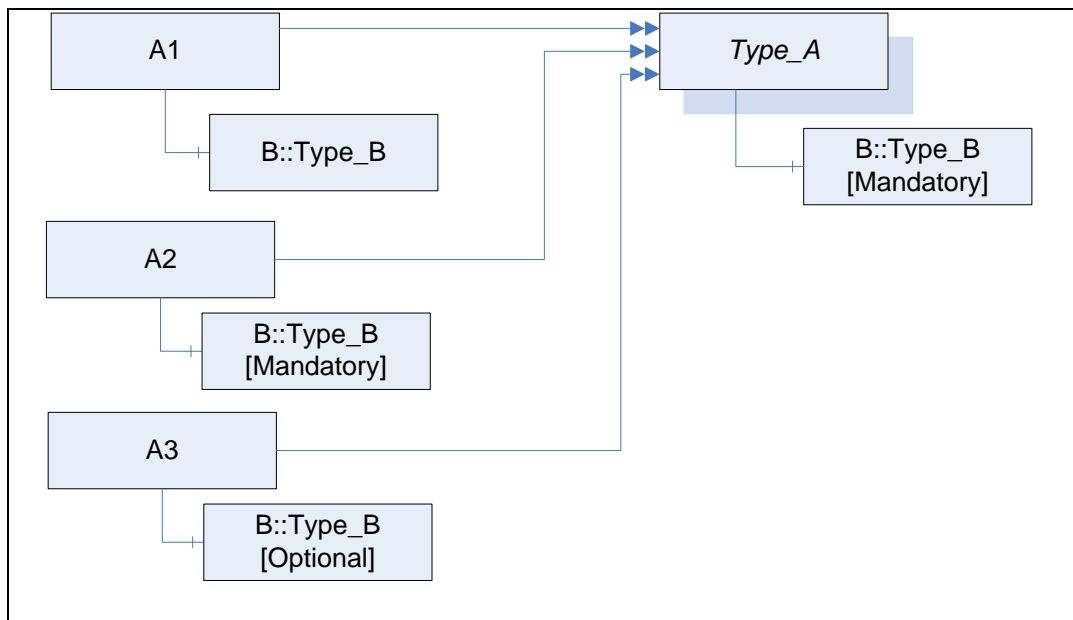

**Figure 17 – Example on changing instances based on InstanceDeclarations**

In the second case, all instances that are referenced directly or indirectly from 'A' based on *InstanceDeclarations* of 'A\_Type' initially maintain the same *ModellingRule* as their *InstanceDeclarations*. The *ModellingRules* may be updated; the allowed changes to the *ModellingRules* of these *Nodes* are the same as those defined for subtyping in 6.4.4.3.

In Figure 18 an example of such a scenario is given. Type\_B uses an *InstanceDeclaration* based on Type\_A (upper part of the Figure). Later on the *ModellingRule* of the *InstanceDeclaration* A1 is changed (lower part of the Figure). A1 has become the *NamingRule* of *Mandatory* (changed from *Optional*).

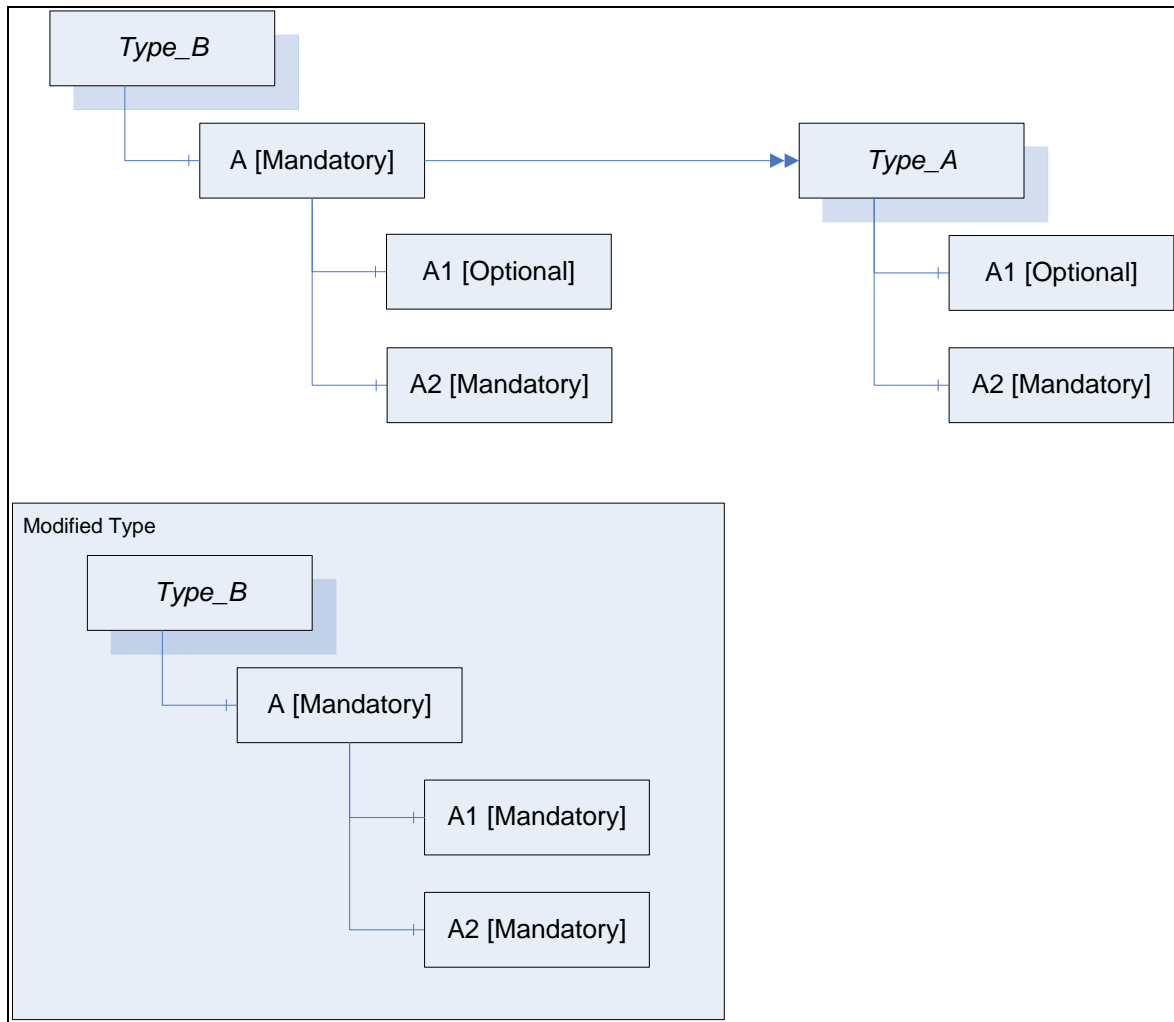

**Figure 18 – Example on changing InstanceDeclarations based on an InstanceDeclaration**

**6.4.4.5 Standard ModellingRules**

**6.4.4.5.1 Titles of Standard ModellingRules**

The remainder of 6.4.4.5 defines *ModellingRules*. In Table 21 the *Properties* of those *ModellingRules* are summarized.

**Table 21 – Properties of ModellingRules**

Title	NamingRule
Mandatory	Mandatory
Optional	Optional
ExposesItsArray	Constraint
OptionalPlaceholder	Constraint
MandatoryPlaceholder	Constraint

**6.4.4.5.2 Mandatory**

An *InstanceDeclaration* marked with the *ModellingRule Mandatory* fulfils exactly the semantic defined for the *NamingRule Mandatory*. That means that for each existing *BrowsePath* on the instance a similar *Node* shall exist, but it is not defined whether a new *Node* is created or an existing *Node* is referenced.

For example, the *TypeDefinitionNode* of a functional block “AI\_BLK\_TYPE” will have a setpoint “SP1”. An instance of this type “AI\_BLK\_1” will have a newly-created setpoint “SP1” as a similar *Node* to the *InstanceDeclaration* SP1. Figure 19 illustrates the example.

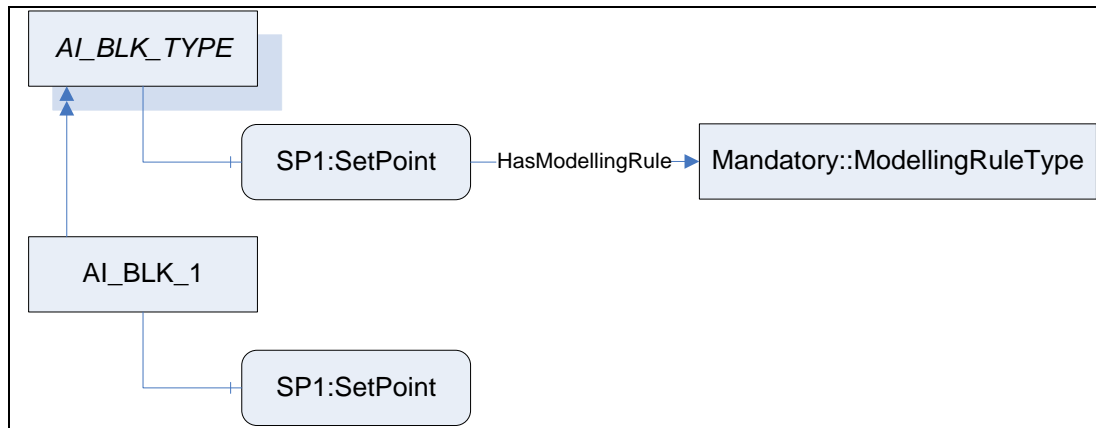

**Figure 19 – Use of the Standard ModellingRule Mandatory**

In 6.4.4.5.3 a complex example combining the *Mandatory* and *Optional ModellingRules* is given.

#### 6.4.4.5.3 Optional

An *InstanceDeclaration* marked with the *ModellingRule Optional* fulfils exactly the semantic defined for the *NamingRule Optional*. That means that for each existing *BrowsePath* on the instance a similar *Node* may exist, but it is not defined whether a new *Node* is created or an existing *Node* is referenced.

In Figure 20 an example using the *ModellingRules Optional* and *Mandatory* is shown. The example contains an *ObjectType* *Type\_A* and all valid combinations of instances named A1 to A13. Note that if the optional B is provided, the mandatory E has to be provided as well, otherwise not. F is referenced by C and D. On the instance, this can be the same *Node* or two different *Nodes* with the same *BrowseName* (similar *Node* to *InstanceDeclaration* F). Not considered in the example is if the instances have *ModellingRules* or not. It is assumed that each F is similar to the *InstanceDeclaration* F, etc.

If there would be a non-hierarchical *Reference* between E and F in the *InstanceDeclaration-Hierarchy*, it is not specified if it occurs in the instance hierarchy or not. In the case of A10, there could be a reference from E to one F but not to the other F, or to both or none of them.

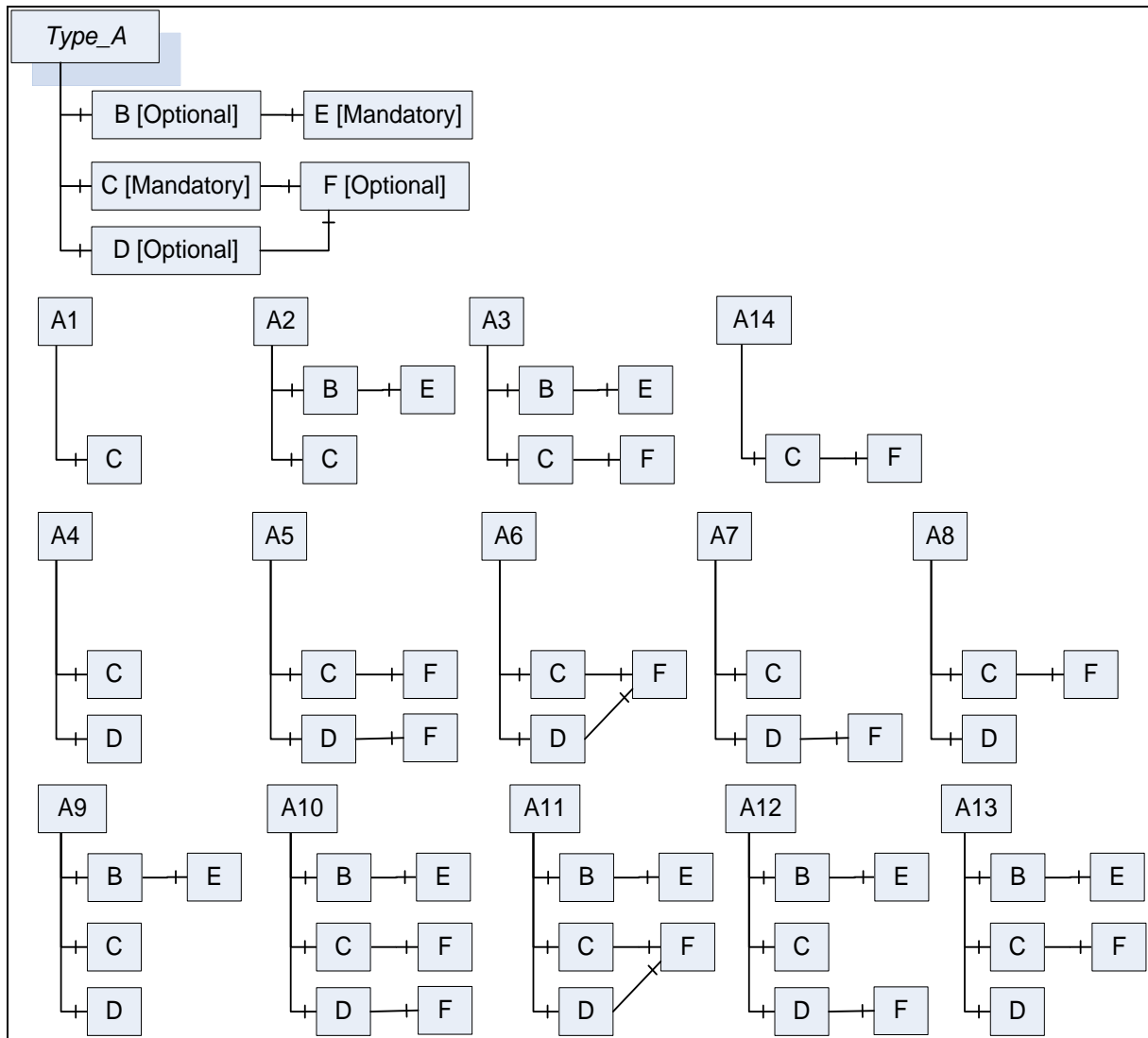

**Figure 20 – Example using the Standard ModellingRules Optional and Mandatory**

**6.4.4.5.4 ExposesItsArray**

The *ExposesItsArray ModellingRule* exposes a special semantic on *VariableTypes* having a single- or multidimensional array as the data type. It indicates that each value of the array will also be exposed as a *Variable* in the *AddressSpace*.

The *ExposesItsArray ModellingRule* can only be applied on *InstanceDeclarations* of *NodeClass Variable* that are part of a *VariableType* having a single- or multidimensional array as its data type.

The *Variable A* having this *ModellingRule* shall be referenced by a forward *hierarchical Reference* from a *VariableType B*. *B* shall have a *ValueRank* value that is equal to or larger than zero. *A* should have a data type that reflects at least parts of the data that is managed in the array of *B*. Each instance of *B* shall reference one instance of *A* for each of its array elements. The used *Reference* shall be of the same type as the *hierarchical Reference* that connects *B* with *A* or a subtype of it. If there are more than one forward *hierarchical References* between *A* and *B*, then all instances based on *B* shall be referenced with all those *References*.

Figure 21 gives an example. *A* is an instance of *Type\_A* having two entries in its value array. Therefore it references two instances of the same type as the *InstanceDeclaration ArrayExpose*. The *BrowseNames* of those instances are not defined by the *ModellingRule*. In general, it is not possible to get a *Variable* representing a specific entry in the array (e.g. the second). *Clients*

will typically either get the array or access the *Variables* directly, so there is no need to provide that information.

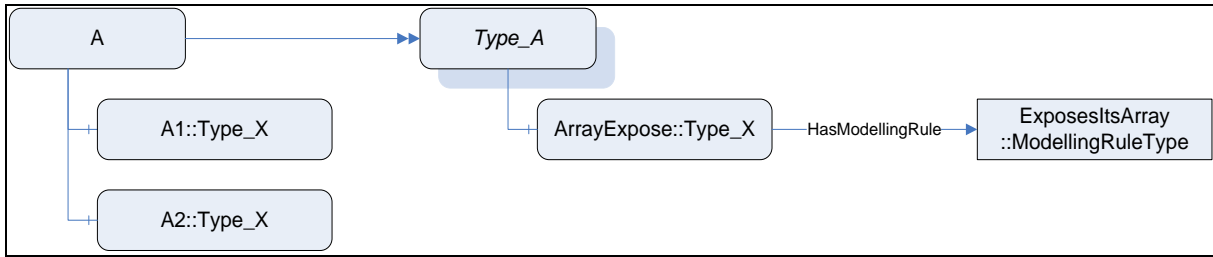

**Figure 21 – Example on using ExposesItsArray**

It is allowed to reference *A* by other *InstanceDeclarations* as well. Those *References* have to be reflected on each instance based on *A*.

Figure 22 gives an example. The *Property* *EUUnit* is referenced by *ArrayExpose* and therefore each instance based on *ArrayExpose* references the instance based on the *InstanceDeclaration* *EUUnit*.

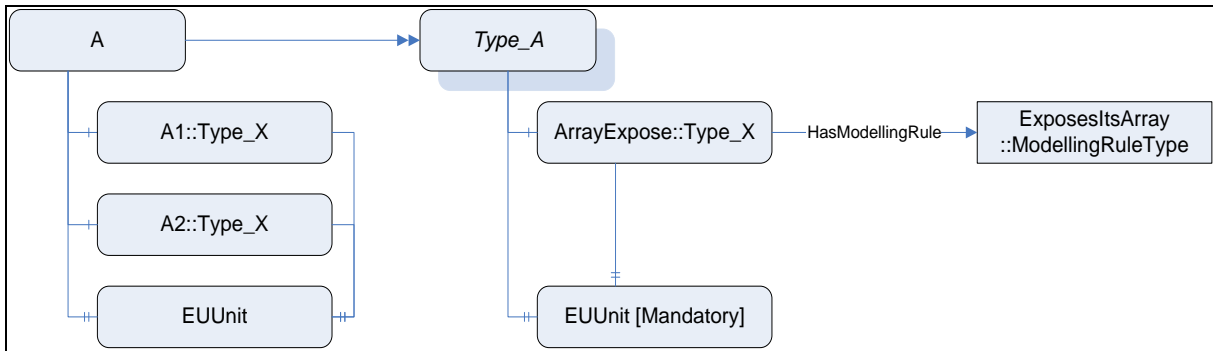

**Figure 22 – Complex example on using ExposesItsArray**

**6.4.4.5.5 OptionalPlaceholder**

For *Object* and *Variable* the intention of the *ModellingRule OptionalPlaceholder* is to expose the information that a complex *TypeDefinition* expects from instances of the *TypeDefinition* to add instances with specific *References* without defining *BrowseNames* for the instances. For example, a *Device* might have a *Folder* for *DeviceParameters*, and the *DeviceParameters* should be connected with a *HasComponent Reference*. However, the names of the *DeviceParameters* are specific to the instances. The example is shown in Figure 23, where an instance *Device A* adds two *DeviceParameters* in the *Folder*.

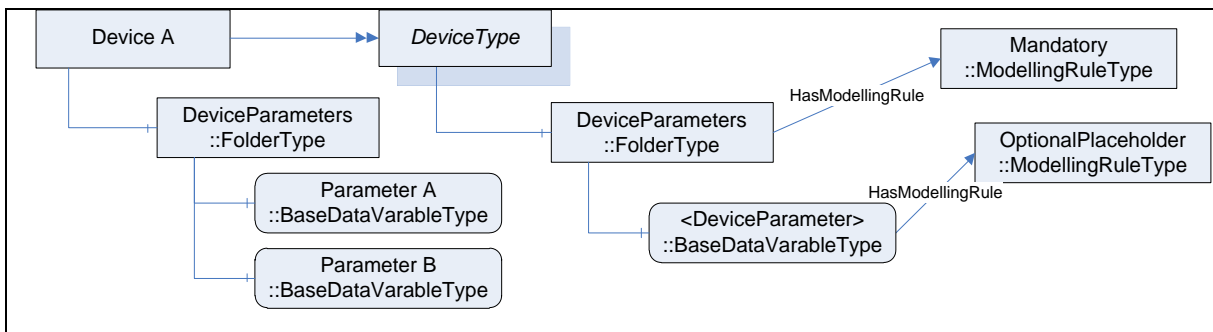

**Figure 23 – Example using OptionalPlaceholder with an Object and Variable**

The *ModellingRule OptionalPlaceholder* adds no additional constraints on instances of the *TypeDefinition*. It just provides useful information when exposing a *TypeDefinition*. When the *InstanceDeclaration* is complex, i.e. it references other *InstanceDeclarations* with hierarchical

References, these *InstanceDeclarations* are not further considered for instantiating the *TypeDefinition*.

It is recommended that the *BrowseName* and the *DisplayName* of *InstanceDeclarations* having the *OptionalPlaceholder ModellingRule* should be enclosed within angle brackets.

When overriding the *InstanceDeclaration*, the *ModellingRule* shall remain *OptionalPlaceholder*.

For *Methods*, the *ModellingRule OptionalPlaceholder* is used to define the *BrowseName* where subtypes and instances provide more information. *The Method definition with the OptionalPlaceholder only defines the BrowseName. An instance or subtype defines the InputArguments and OutputArguments. A subtype shall also change the ModellingRule to Optional or Mandatory. The Method is optional for instances. For example, a Device might have a Method to perform calibration however the specific arguments for the Method depend on the instance of the Device. In this example Device A does not implement the Method, Device B implements the Method with no arguments and Device C implements the Method accepting a mode argument to select how the calibration is to be performed. The example is shown in Figure 24.*

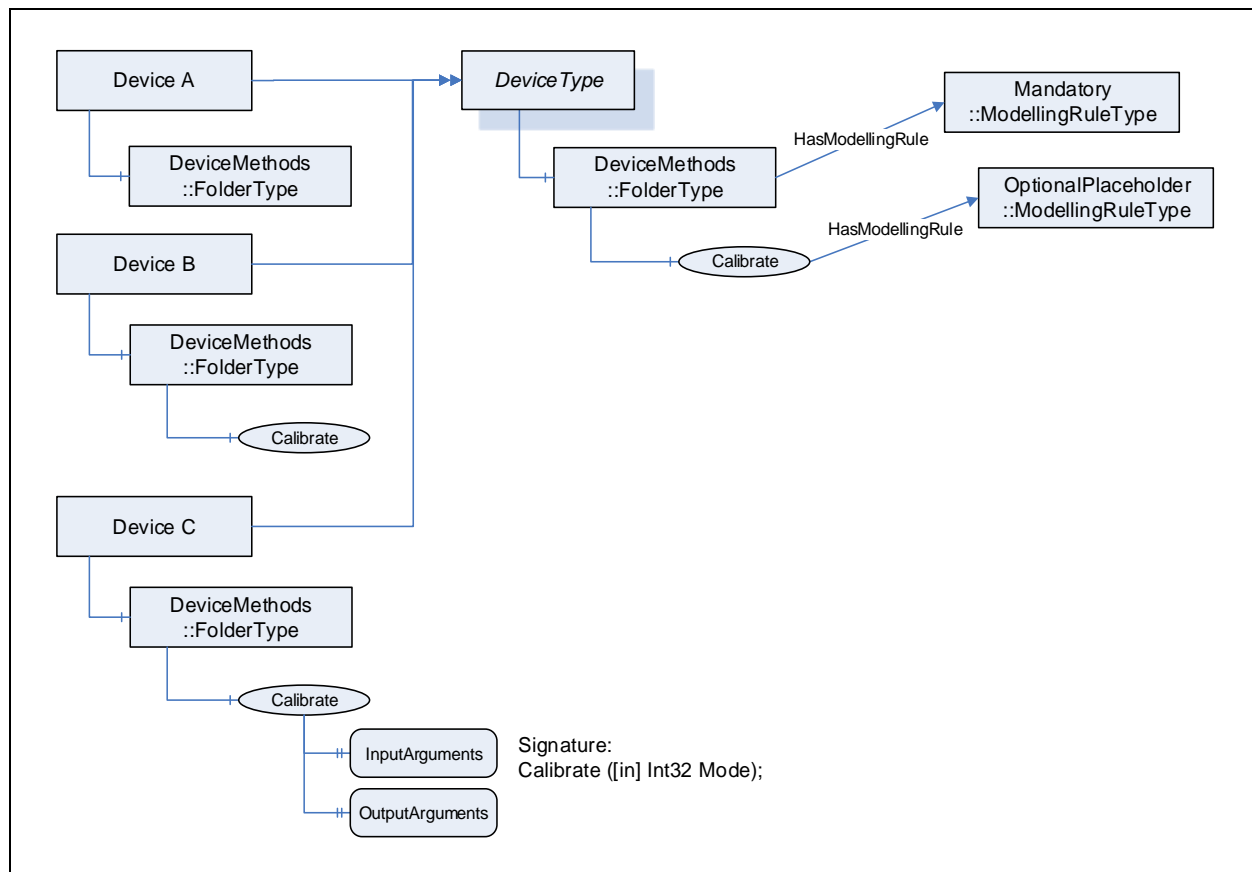

Figure 24 – Example using OptionalPlaceholder with a Method

#### 6.4.4.5.6 MandatoryPlaceholder

For *Object* and *Variable* the *ModellingRule MandatoryPlaceholder* has a similar intention as the *ModellingRule OptionalPlaceholder*. It exposes the information that a *TypeDefinition* expects of instances of the *TypeDefinition* to add instances defined by the *InstanceDeclaration*. However, *MandatoryPlaceholder* requires that at least one of those instances shall exist.

For example, when the *DeviceType* requires that at least one *DeviceParameter* shall exist without specifying the *BrowseName* for it, it uses *MandatoryPlaceholder* as shown in Figure 25. *Device A* is a valid instance as it has the required *DeviceParameter*. *Device B* is not valid as it uses the wrong *ReferenceType* to reference a *DeviceParameter* (*Organizes* instead

of *HasComponent*) and Device C is not valid because it does not provide a *DeviceParameter* at all.

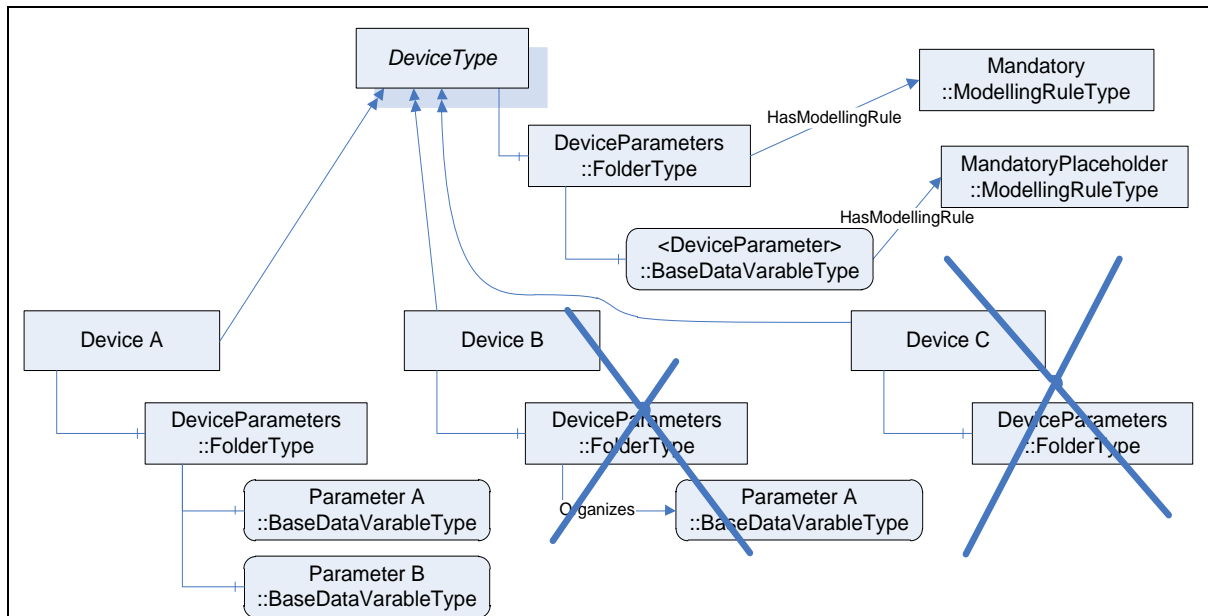

**Figure 25 – Example on using MandatoryPlaceholder for Object and Variable**

The *ModellingRule MandatoryPlaceholder* requires that each instance provides at least one instance with the *TypeDefinition* of the *InstanceDeclaration* or a subtype, and is referenced with the same *ReferenceType* or a subtype as the *InstanceDeclaration*. It does not require a specific *BrowseName* and thus cannot be used for the *TranslateBrowsePathsToNodeIds Service* (see OPC 10000-4).

When the *InstanceDeclaration* is complex, i.e. it references other *InstanceDeclarations* with hierarchical *References*, these *InstanceDeclarations* are not further considered for instantiating the *TypeDefinition*.

It is recommended that the *BrowseName* and the *DisplayName* of *InstanceDeclarations* having the *MandatoryPlaceholder ModellingRule* should be enclosed within angle brackets.

When overriding the *InstanceDeclaration*, the *ModellingRule* shall remain *MandatoryPlaceholder*.

For *Methods*, the *ModellingRule MandatoryPlaceholder* is used to define the *BrowseName* where subtypes and instances provide more information. *The Method definition with the MandatoryPlaceholder only defines the BrowseName. An instance or subtype defines the InputArguments and OutputArguments. A subtype shall also change the ModellingRule to Mandatory. The Method is mandatory for instances.*

## 6.5 Changing Type Definitions that are already used

There is no behaviour specified regarding subtypes and instances when changing *ObjectTypes* and *VariableTypes*. It is *Server-dependent*, if those changes are reflected on the subtypes and instances of the types. However, all constraints defined for subtypes and instances have to be fulfilled. For example, it is not allowed to add a *Property* using the *ModellingRule Mandatory* on a type if instances of this type exist without the *Property*. In that case, the *Server* either has to add the *Property* to all instances of the type or adding the *Property* on the type has to be rejected.



## 7 Standard ReferenceTypes

### 7.1 General

This standard defines *ReferenceTypes* as an inherent part of the OPC UA Address Space Model. Figure 26 informally describes the hierarchy of these *ReferenceTypes*. Other parts of this series of standards may specify additional *ReferenceTypes*. The remainder of 7 defines the *ReferenceTypes*. OPC 10000-5 defines their representation in the *AddressSpace*.

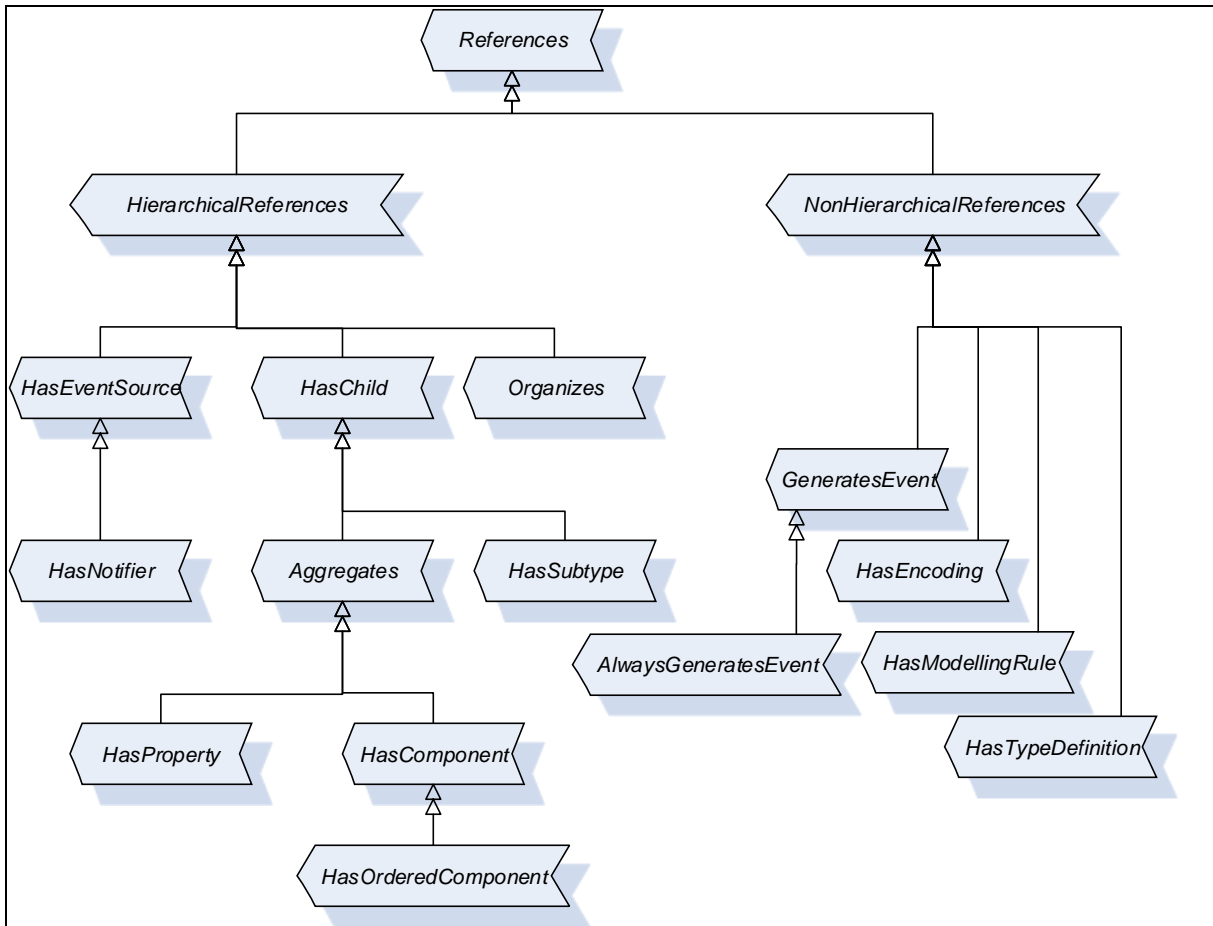

Figure 26 – Standard ReferenceType Hierarchy

### 7.2 References ReferenceType

The *References ReferenceType* is an abstract *ReferenceType*; only subtypes of it can be used.

There is no semantic associated with this *ReferenceType*. This is the base type of all *ReferenceTypes*. All *ReferenceTypes* shall be a subtype of this base *ReferenceType* – either direct or indirect. The main purpose of this *ReferenceType* is allowing simple filter and queries in the corresponding *Services* of OPC 10000-5.

There are no constraints defined for this abstract *ReferenceType*.

### 7.3 HierarchicalReferences ReferenceType

The *HierarchicalReferences ReferenceType* is an abstract *ReferenceType*; only subtypes of it can be used.

The semantic of *HierarchicalReferences* is to denote that *References* of *HierarchicalReferences* span a hierarchy. It means that it may be useful to present *Nodes* related with *References* of this type in a hierarchical-like way. *HierarchicalReferences* does not forbid loops. For example, starting from *Node “A”* and following *HierarchicalReferences* it may be possible to browse to *Node “A”*, again.

It is not permitted to have a *Property* as *SourceNode* of a *Reference* of any subtype of this abstract *ReferenceType*.

It is not allowed that the *SourceNode* and the *TargetNode* of a *Reference* of the *ReferenceType HierarchicalReferences* are the same, that is, it is not allowed to have self-references using *HierarchicalReferences*.

#### 7.4 NonHierarchicalReferences ReferenceType

The *NonHierarchicalReferences ReferenceType* is an abstract *ReferenceType*; only subtypes of it can be used.

The semantic of *NonHierarchicalReferences* is to denote that its subtypes do not span a hierarchy and should not be followed when trying to present a hierarchy. To distinguish hierarchical and non-hierarchical *References*, all concrete *ReferenceTypes* shall inherit from either *hierarchical References* or *non-hierarchical References*, either direct or indirect.

There are no constraints defined for this abstract *ReferenceType*.

#### 7.5 HasChild ReferenceType

The *HasChild ReferenceType* is an abstract *ReferenceType*; only subtypes of it can be used. It is a subtype of *HierarchicalReferences*.

The semantic is to indicate that *References* of this type span a non-looping hierarchy.

Starting from *Node* "A" and only following *References* of the subtypes of the *HasChild ReferenceType* it shall never be possible to return to "A". But it is allowed that following the *References* there may be more than one path leading to another *Node* "B".

#### 7.6 Aggregates ReferenceType

The *Aggregates ReferenceType* is an abstract *ReferenceType*; only subtypes of it can be used. It is a subtype of *HasChild*.

The semantic is to indicate a part (the *TargetNode*) belongs to the *SourceNode*. It does not specify the ownership of the *TargetNode*.

There are no constraints defined for this abstract *ReferenceType*.

#### 7.7 HasComponent ReferenceType

The *HasComponent ReferenceType* is a concrete *ReferenceType* that can be used directly. It is a subtype of the *Aggregates ReferenceType*.

The semantic is a part-of relationship. The *TargetNode* of a *Reference* of the *HasComponent ReferenceType* is a part of the *SourceNode*. This *ReferenceType* is used to relate *Objects* or *ObjectTypes* with their containing *Objects*, *DataVariables*, and *Methods*. This *ReferenceType* is also used to relate complex *Variables* or *VariableTypes* with their *DataVariables*.

Like all other *ReferenceTypes*, this *ReferenceType* does not specify anything about the ownership of the parts, although it represents a part-of relationship semantic. That is, it is not specified if the *TargetNode* of a *Reference* of the *HasComponent ReferenceType* is deleted when the *SourceNode* is deleted.

The *TargetNode* of this *ReferenceType* shall be a *Variable*, an *Object* or a *Method*.

If the *TargetNode* is a *Variable*, the *SourceNode* shall be an *Object*, an *ObjectType*, a *DataVariable* or a *VariableType*. By using the *HasComponent Reference*, the *Variable* is defined as *DataVariable*.

If the *TargetNode* is an *Object* or a *Method*, the *SourceNode* shall be an *Object* or *ObjectType*.

## 7.8 HasProperty ReferenceType

The *HasProperty ReferenceType* is a concrete *ReferenceType* that can be used directly. It is a subtype of the *Aggregates ReferenceType*.

The semantic is to identify the *Properties* of a *Node*. *Properties* are described in 4.4.2.

The *SourceNode* of this *ReferenceType* can be of any *NodeClass*. The *TargetNode* shall be a *Variable*. By using the *HasProperty Reference*, the *Variable* is defined as *Property*. Since *Properties* shall not have *Properties*, a *Property* shall never be the *SourceNode* of a *HasProperty Reference*.

## 7.9 HasOrderedComponent ReferenceType

The *HasOrderedComponent ReferenceType* is a concrete *ReferenceType* that can be used directly. It is a subtype of the *HasComponent ReferenceType*.

The semantic of the *HasOrderedComponent ReferenceType* – besides the semantic of the *HasComponent ReferenceType* – is that when browsing from a *Node* and following *References* of this type or its subtype all *References* are returned in the Browse *Service* defined in OPC 10000-4 in a well-defined order. The order is *Server*-specific, but the *Client* can assume that the *Server* always returns them in the same order.

There are no additional constraints defined for this *ReferenceType*.

## 7.10 HasSubtype ReferenceType

The *HasSubtype ReferenceType* is a concrete *ReferenceType* that can be used directly. It is a subtype of the *HasChild ReferenceType*.

The semantic of *this ReferenceType* is to express a subtype relationship of types. It is used to span the *ReferenceType* hierarchy, whose semantic is specified in 5.3.3.3; a *DataType* hierarchy is specified in 5.8.3, and other subtype hierarchies are specified in Clause 6.

The *SourceNode* of *References* of this type shall be an *ObjectType*, a *VariableType*, a *DataType* or a *ReferenceType* and the *TargetNode* shall be of the same *NodeClass* as the *SourceNode*. Each *ReferenceType* shall be the *TargetNode* of at most one *Reference* of type *HasSubtype*.

## 7.11 Organizes ReferenceType

The *Organizes ReferenceType* is a concrete *ReferenceType* and can be used directly. It is a subtype of *HierarchicalReferences*.

The semantic of this *ReferenceType* is to organise *Nodes* in the *AddressSpace*. It can be used to span multiple hierarchies independent of any hierarchy created with the non-looping *Aggregates References*.

The *SourceNode* of *References* of this type shall be an *Object* or a *View*. If it is an *Object* then it should be an *Object* of the *ObjectType FolderType* or one of its subtypes (see 5.5.3).

The *TargetNode* of this *ReferenceType* can be of any *NodeClass*.

## 7.12 HasModellingRule ReferenceType

The *HasModellingRule ReferenceType* is a concrete *ReferenceType* and can be used directly. It is a subtype of *NonHierarchicalReferences*.

The semantic of this *ReferenceType* is to bind the *ModellingRule* to an *Object*, *Variable* or *Method*. The *ModellingRule* mechanisms are described in 6.4.4.

The *SourceNode* of this *ReferenceType* shall be an *Object*, *Variable* or *Method*. The *TargetNode* shall be an *Object* of the *ObjectType* “ModellingRule” or one of its subtypes.

Each *Node* shall be the *SourceNode* of at most one *HasModellingRule Reference*.

### 7.13 HasTypeDefinition ReferenceType

The HasTypeDefinition ReferenceType is a concrete ReferenceType and can be used directly. It is a subtype of NonHierarchicalReferences.

The semantic of this *ReferenceType* is to bind an *Object* or *Variable* to its *ObjectType* or *VariableType*, respectively. The relationships between types and instances are described in 4.5.

The *SourceNode* of this *ReferenceType* shall be an *Object* or *Variable*. If the *SourceNode* is an *Object*, then the *TargetNode* shall be an *ObjectType*; if the *SourceNode* is a *Variable*, then the *TargetNode* shall be a *VariableType*.

Each *Variable* and each *Object* shall be the *SourceNode* of exactly one *HasTypeDefinition Reference*.

### 7.14 HasEncoding ReferenceType

The *HasEncoding ReferenceType* is a concrete *ReferenceType* and can be used directly. It is a subtype of *NonHierarchicalReferences*.

The semantic of this *ReferenceType* is to reference *DataTypeEncodings* of a subtype of the *Structure DataType*.

The *SourceNode* of *References* of this type shall be a subtype of the *Structure DataType*.

The *TargetNode* of this *ReferenceType* shall be an *Object* of the *ObjectType DataTypeEncodingType* or one of its subtypes (see 5.8.4).

### 7.15 GeneratesEvent

The *GeneratesEvent ReferenceType* is a concrete *ReferenceType* and can be used directly. It is a subtype of *NonHierarchicalReferences*.

The semantic of this *ReferenceType* is to identify the types of *Events* instances of *ObjectTypes* or *VariableTypes* may generate and *Methods* may generate on each *Method* call.

The *SourceNode* of *References* of this type shall be an *ObjectType*, a *VariableType* or a *Method*.

The *TargetNode* of this *ReferenceType* shall be an *ObjectType* representing *EventTypes*, that is, the *BaseEventType* or one of its subtypes.

### 7.16 AlwaysGeneratesEvent

The *AlwaysGeneratesEvent ReferenceType* is a concrete *ReferenceType* and can be used directly. It is a subtype of *GeneratesEvent*.

The semantic of this *ReferenceType* is to identify the types of *Events* *Methods* have to generate on each *Method* call.

The *SourceNode* of *References* of this type shall be a *Method*.

The *TargetNode* of this *ReferenceType* shall be an *ObjectType* representing *EventTypes*, that is, the *BaseEventType* or one of its subtypes.

### 7.17 HasEventSource

The *HasEventSource ReferenceType* is a concrete *ReferenceType* and can be used directly. It is a subtype of *HierarchicalReferences*.

The semantic of this *ReferenceType* is to relate event sources in a hierarchical, non-looping organization. This *ReferenceType* and any subtypes are intended to be used for discovery of *Event* generation in a *Server*. They are not required to be present for a *Server* to generate an *Event* from its source (causing the *Event*) to its notifying *Nodes*. In particular, the root notifier of a *Server*, the *Server Object* defined in OPC 10000-5, is always capable of supplying all

Events from a Server and as such has implied *HasEventSource ReferenceType* to every event source in a Server.

The *SourceNode* of this *ReferenceType* shall be an *Object* that is a source of event subscriptions. A source of event subscriptions is an *Object* that has its “SubscribeToEvents” bit set within the *EventNotifier Attribute*.

The *TargetNode* of this *ReferenceType* can be a *Node* of any *NodeClass* that can generate event notifications via a subscription to the reference source.

Starting from *Node* “A” and only following *References* of the *HasEventSource ReferenceType* or of its subtypes it shall never be possible to return to “A”. But it is permitted that, following the *References*, there may be more than one path leading to another *Node* “B”.

### 7.18 HasNotifier

The *HasNotifier ReferenceType* is a concrete *ReferenceType* and can be used directly. It is a subtype of *HasEventSource*.

The semantic of this *ReferenceType* is to relate *Object Nodes* that are notifiers with other notifier *Object Nodes*. The *ReferenceType* is used to establish a hierarchical organization of event notifying *Objects*. It is a subtype of the *HasEventSource ReferenceType* defined in 7.16.

The *SourceNode* of this *ReferenceType* shall be *Objects* or *Views* that are a source of event subscriptions. The *TargetNode* of this *ReferenceType* shall be *Objects* that are a source of event subscriptions. A source of event subscriptions is an *Object* that has its “SubscribeToEvents” bit set within the *EventNotifier Attribute*.

If the *TargetNode* of a *Reference* of this type generates an *Event*, then this *Event* shall also be provided in the *SourceNode* of the *Reference*.

An example of a possible organization of *Event References* is represented in Figure 27. In this example an unfiltered *Event* subscription directed to the “Pump” *Object* will provide the *Event* sources “Start” and “Stop” to the subscriber. An unfiltered *Event* subscription directed to the “Area 1” *Object* will provide *Event* sources from “Machine B”, “Tank A” and all notifier sources below “Tank A”.

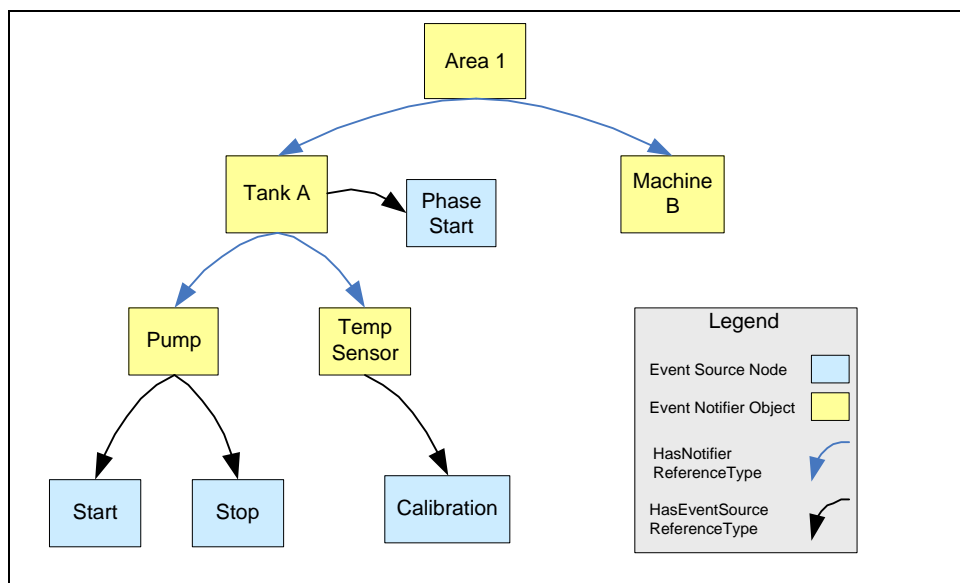

Figure 27 – Event Reference Example

A second example of a more complex organization of *Event References* is represented in Figure 28. In this example, explicit *References* are included from the *Server’s Server Object*, which is a source of all *Server Events*. A second *Event* organization has been introduced to collect the *Events* related to “Tank Farm 1”. An unfiltered *Event* subscription directed to the “Tank Farm 1”

*Object* will provide *Event* sources from “Tank B”, “Tank A” and all notifier sources below “Tank B” and “Tank A”.

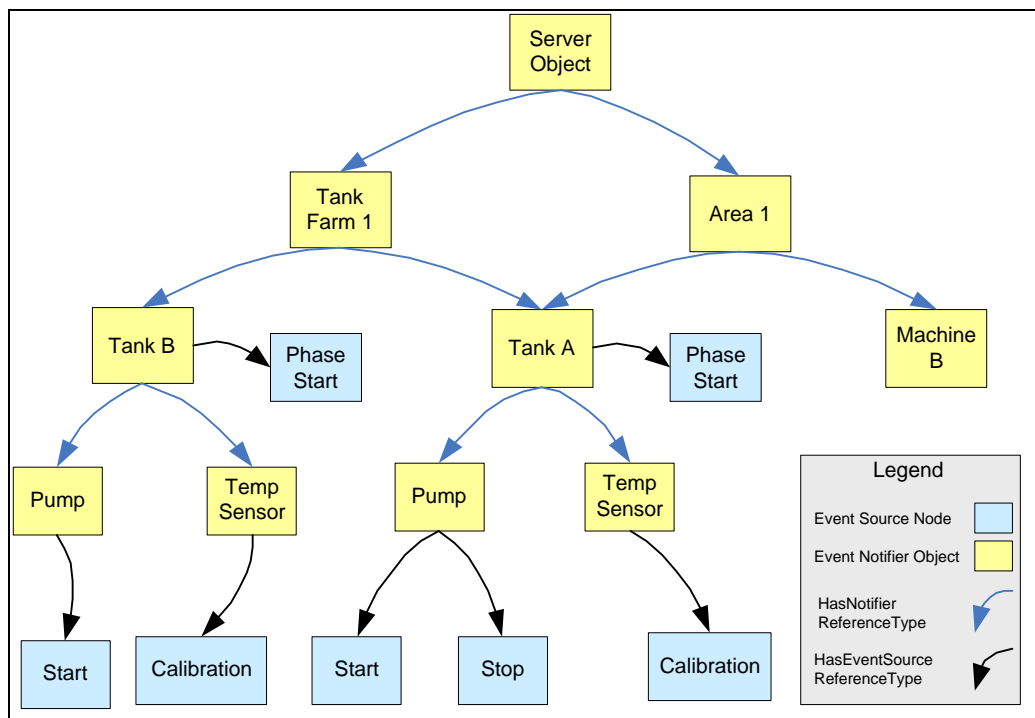

Figure 28 – Complex Event Reference Example

## 8 Standard DataTypes

### 8.1 General

The remainder of 8 defines *DataTypes*. Their representation in the *AddressSpace* and the *DataType* hierarchy is specified in OPC 10000-5. Other parts of this series of standards may specify additional *DataTypes*.

### 8.2 Nodeld

#### 8.2.1 General

This *Built-in DataType* is composed of three elements that identify a *Node* within a *Server*. They are defined in Table 22.

Table 22 – Nodeld Definition

Name	Type	Description
Nodeld	structure	
namespaceIndex	UInt16	The index for a namespace URI (see 8.2.2).
identifierType	Enum	The format and data type of the identifier (see 8.2.3).
identifier	*	The identifier for a <i>Node</i> in the <i>AddressSpace</i> of an OPC UA <i>Server</i> (see 8.2.4).

See OPC 10000-6 for a description of the encoding of the identifier into OPC UA Messages.

#### 8.2.2 NamespaceIndex

The namespace is a URI that identifies the naming authority responsible for assigning the identifier element of the *Nodeld*. Naming authorities include the local *Server*, the underlying system, standards bodies and consortia. It is expected that most *Nodes* will use the URI of the *Server* or of the underlying system.

Using a namespace URI allows multiple OPC UA *Servers* attached to the same underlying system to use the same identifier to identify the same *Object*. This enables *Clients* that connect to those *Servers* to recognise *Objects* that they have in common.

Namespace URIs, like *Server* names, are identified by numeric values in OPC UA *Services* to permit more efficient transfer and processing (e.g. table lookups). The numeric values used to identify namespaces correspond to the index into the *NamespaceArray*. The *NamespaceArray* is a *Variable* that is part of the *Server Object* in the *AddressSpace* (see OPC 10000-5 for its definition).

The URI for the OPC UA namespace is:

"http://opcfoundation.org/UA/"

Its corresponding index in the namespace table is 0.

The namespace URI is case sensitive.

### 8.2.3 IdentifierType

The *IdentifierType* element identifies the type of the *NodeId*, its format and its scope. Its values are defined in Table 23.

**Table 23 – IdentifierType Values**

Value	Description
NUMERIC_0	Numeric value
STRING_1	String value
GUID_2	Globally Unique Identifier
OPAQUE_3	Namespace specific format

Normally the scope of *NodeIds* is the *Server* in which they are defined. For certain types of *NodeIds*, *NodeIds* can uniquely identify a *Node* within a system, or across systems (e.g. GUIDs). System-wide and globally-unique identifiers allow *Clients* to track *Nodes*, such as work orders, as they move between OPC UA *Servers* as they progress through the system.

Opaque identifiers are identifiers that are free-format byte strings that might or might not be human interpretable.

String identifiers are case sensitive. That is, *Clients* shall consider them case sensitive. *Servers* are allowed to provide alternative *NodeIds* (see 5.2.2) and using this mechanism servers can handle *NodeIds* as case insensitive.

### 8.2.4 Identifier value

The identifier value element is used within the context of the first three elements to identify the *Node*. Its data type and format is defined by the *IdType*.

Identifier values of *IdType* STRING\_1 are restricted to 4 096 characters. Identifier values of *IdType* OPAQUE\_3 are restricted to 4 096 bytes.

A null *NodeId* has special meaning. For example, many services defined in OPC 10000-4 define special behaviour if a null *NodeId* is passed as a parameter. Each *IdType* has a set of identifier values that represent a null *NodeId*. These values are summarised in Table 24.

**Table 24 – NodeId Null Values**

IdType	Identifier
NUMERIC_0	0
STRING_1	A null or Empty String ("")
GUID_2	A Guid initialised with zeros (e.g. 00000000-0000-0000-0000-00000000)
OPAQUE_3	A ByteString with Length=0

A null *NodeId* always has a *NamespaceIndex* equal to 0.

A *Node* in the *AddressSpace* shall not have a null as its *NodeId*.

### 8.3 QualifiedName

This *Built-in DataType* contains a qualified name. It is, for example, used as *BrowseName*. Its elements are defined in Table 25. The name part of the *QualifiedName* is restricted to 512 characters.

**Table 25 – QualifiedName Definition**

Name	Type	Description
QualifiedName	structure	
namespaceIndex	UInt16	Index that identifies the namespace that defines the name. This index is the index of that namespace in the local <i>Server's NamespaceArray</i> . The <i>Client</i> may read the <i>NamespaceArray Variable</i> to access the string value of the namespace.
name	String	The text portion of the <i>QualifiedName</i> .

### 8.4 LocaleId

This *Simple DataType* is specified as a string that is composed of a language component and a country/region component as specified by <https://www.iso.org/standard/57469.html> IETF RFC 5646. The <country/region> component is always preceded by a hyphen. The format of the *LocaleId* string is shown below:

<language>[-<country/region>], where  
 <language> is the two letter ISO 639 code for a language,  
 <country/region> is the two letter ISO 3166 code for the country/region.

The rules for constructing *LocaleIds* defined by <https://www.iso.org/standard/57469.html> IETF RFC 5646 are restricted as follows:

- this specification permits only zero or one <country/region> component to follow the <language> component;
- this specification also permits the “-CHS” and “-CHT” three-letter <country/region> codes for “Simplified” and “Traditional” Chinese locales;
- this specification also allows the use of other <country/region> codes as deemed necessary by the *Client* or the *Server*.

Table 26 shows examples of OPC UA *LocaleIds*. *Clients* and *Servers* always provide *LocaleIds* that explicitly identify the language and the country/region.

**Table 26 – LocaleId Examples**

Locale	OPC UA LocaleId
English	en
English (US)	en-US
German	de
German (Germany)	de-DE
German (Austrian)	de-AT

An empty or null string indicates that the *LocaleId* is unknown.

### 8.5 LocalizedText

This *Built-in DataType* defines a structure containing a String in a locale-specific translation specified in the identifier for the locale. Its elements are defined in Table 27.

**Table 27 – LocalizedText Definition**

Name	Type	Description
LocalizedText	structure	
locale	LocaleId	The identifier for the locale (e.g. “en-US”).
text	String	The localized text.



## 8.6 Argument

This *Structured DataType* defines a *Method* input or output argument specification. It is for example used in the input and output argument *Properties* for *Methods*. Its elements are described in Table 28.

**Table 28 – Argument Definition**

Name	Type	Description
Argument	structure	
name	String	The name of the argument.
dataType	NodeId	The <i>NodeId</i> of the <i>DataType</i> of this argument.
valueRank	Int32	Indicates whether the <i>dataType</i> is an array and how many dimensions the array has. It may have the following values: <i>n</i> > 1: the <i>dataType</i> is an array with the specified number of dimensions. OneDimension (1): The <i>dataType</i> is an array with one dimension. OneOrMoreDimensions (0): The <i>dataType</i> is an array with one or more dimensions. Scalar (-1): The <i>dataType</i> is not an array. Any (-2): The <i>dataType</i> can be a scalar or an array with any number of dimensions. ScalarOrOneDimension (-3): The <i>dataType</i> can be a scalar or a one dimensional array. NOTE All <i>DataTypes</i> are considered to be scalar, even if they have array-like semantics like <i>ByteString</i> and <i>String</i> .
arrayDimensions	UInt32[]	This field specifies the maximum supported length of each dimension. If the maximum is unknown the value shall be 0. The number of elements shall be equal to the value of the <i>valueRank</i> field. This field shall be null if <i>valueRank</i> ≤ 0. The maximum number of elements of an array transferred on the wire is 2147483647 (max Int32).
description	LocalizedText	A localised description of the argument.

## 8.7 BaseDataType

This abstract *DataType* defines a value that can have any valid *DataType*.

It defines a special value null indicating that a value is not present.

## 8.8 Boolean

This *Built-in DataType* defines a value that is either TRUE or FALSE.

## 8.9 Byte

This *Built-in DataType* defines a value in the range of 0 to 255.

## 8.10 ByteString

This *Built-in DataType* defines a value that is a sequence of Byte values.

## 8.11 DateTime

This *Built-in DataType* defines a Gregorian calendar date. Details about this *DataType* are defined in OPC 10000-6.

## 8.12 Double

This *Built-in DataType* defines a value that adheres to the [ISO/IEC/IEEE 60559:2011](#) double precision data type definition.

## 8.13 Duration

This *Simple DataType* is a *Double* that defines an interval of time in milliseconds (fractions can be used to define sub-millisecond values). Negative values are generally invalid but may have special meanings where the *Duration* is used.

## 8.14 Enumeration

This abstract *DataType* is the base *DataType* for all enumeration *DataTypes* like *NodeClass* defined in 8.30. All *DataTypes* inheriting from this *DataType* have special handling for the encoding as defined in OPC 10000-6. All enumeration *DataTypes* shall inherit from this *DataType*.

Some special rules apply when subtyping enumerations. Any enumeration *DataType* not directly inheriting from the *Enumeration DataType* can only restrict the enumeration values of its supertype. That is, it shall neither add enumeration values nor change the text associated to the enumeration value. As an example, the enumeration Days having {'Mo', 'Tu', 'We', 'Th', 'Fr', 'Sa', 'Su'} as values can be subtyped to the enumeration Workdays having {'Mo', 'Tu', 'We', 'Th', 'Fr'}. The other direction, subtyping Workdays to Days would not be allowed as Days has values not allowed by Workdays ('Sa' and 'Su').

## 8.15 Float

This *Built-in DataType* defines a value that adheres to the ISO/IEC/IEEE 60559:2011 single precision data type definition.

## 8.16 Guid

This *Built-in DataType* defines a value that is a 128-bit Globally Unique Identifier. Details about this *DataType* are defined in OPC 10000-6.

## 8.17 SByte

This *Built-in DataType* defines a value that is a signed integer between -128 and 127 inclusive.

## 8.18 IdType

This *DataType* is an enumeration that identifies the *IdType* of a *NodeId*. Its values are defined in Table 23. See 8.2.3 for a description of the use of this *DataType* in *NodeIds*.

## 8.19 Image

This abstract *DataType* defines a *ByteString* representing an image.

## 8.20 ImageBMP

This *Simple DataType* defines a *ByteString* representing an image in BMP format.

## 8.21 ImageGIF

This *Simple DataType* defines a *ByteString* representing an image in GIF format.

## 8.22 ImageJPG

This *Simple DataType* defines a *ByteString* representing an image in JPG format.

## 8.23 ImagePNG

This *Simple DataType* defines a *ByteString* representing an image in PNG format.

## 8.24 Integer

This abstract *DataType* defines an integer whose length is defined by its subtypes.

## 8.25 Int16

This *Built-in DataType* defines a value that is a signed integer between -32 768 and 32 767 inclusive.

## 8.26 Int32

This *Built-in DataType* defines a value that is a signed integer between -2 147 483 648 and 2 147 483 647 inclusive.

### 8.27 Int64

This *Built-in DataType* defines a value that is a signed integer between -9 223 372 036 854 775 808 and 9 223 372 036 854 775 807 inclusive.

### 8.28 TimeZoneDataType

This *Structured DataType* defines the local time that may or may not take daylight saving time into account. Its elements are described in Table 29.

**Table 29 – TimeZoneDataType Definition**

Name	Type	Description
TimeZoneDataType	structure	
offset	Int16	The offset in minutes from UtcTime
daylightSavingInOffset	Boolean	If TRUE, then daylight saving time (DST) is in effect and <i>offset</i> includes the DST correction. If FALSE then the <i>offset</i> does not include the DST correction and DST may or may not have been in effect.

### 8.29 NamingRuleType

This *DataType* is an enumeration that identifies the *NamingRule* (see 6.4.4.2.1). Its values are defined in Table 30.

**Table 30 – NamingRuleType Values**

Name
MANDATORY_1
OPTIONAL_2
CONSTRAINT_3

### 8.30 NodeClass

This *DataType* is an enumeration that identifies a *NodeClass*. Its values are defined in Table 31.

**Table 31 – NodeClass Values**

Name
OBJECT_1
VARIABLE_2
METHOD_4
OBJECT_TYPE_8
VARIABLE_TYPE_16
REFERENCE_TYPE_32
DATA_TYPE_64
VIEW_128

### 8.31 Number

This abstract *DataType* defines a number. Details are defined by its subtypes.

### 8.32 String

This *Built-in DataType* defines a Unicode character string that should exclude control characters that are not whitespaces.

### 8.33 Structure

This abstract *DataType* is the base *DataType* for all *Structured DataTypes* like *Argument* defined in 8.6. All *DataTypes* inheriting from this *DataType* have special handling for the encoding as defined in OPC 10000-6.

### 8.34 UInteger

This abstract *DataType* defines an unsigned integer whose length is defined by its subtypes.

### 8.35 UInt16

This *Built-in DataType* defines a value that is an unsigned integer between 0 and 65 535 inclusive.

### 8.36 UInt32

This *Built-in DataType* defines a value that is an unsigned integer between 0 and 4 294 967 295 inclusive.

### 8.37 UInt64

This *Built-in DataType* defines a value that is an unsigned integer between 0 and 18 446 744 073 709 551 615 inclusive.

### 8.38 UtcTime

This *simple DataType* is a *DateTime* used to define Coordinated Universal Time (UTC) values. All time values conveyed between OPC UA *Servers* and *Clients* are UTC values. *Clients* shall provide any conversions between UTC and local time.

UTC has the concept of leap seconds. Leap seconds can lead to repeating seconds. Therefore applications are allowed to use TAI (International Atomic Time) instead of UTC in any place where *UtcTime* is used. Details on time synchronization are discussed in OPC 10000-6.

It should be noted that the Source and Server Timestamps may originate from different clocks that have no synchronization. It is also possible that one may use UTC while the other uses TAI.

### 8.39 XmlElement

This *Built-in DataType* is used to define XML elements. OPC 10000-6 defines details about this *DataType*.

XML data can always be modelled as a subtype of the *Structure DataType* with a single *DataTypeEncoding* that represents the XML complexType that defines the XML element (it is not necessary to have access to the XML Schema to define a *DataTypeEncoding*). For this reason a *Server* should never define *Variables* that use the *XmlElement DataType* unless the *Server* has no information about the XML elements that might be in the *Variable Value*.

### 8.40 EnumValueType

This *Structured DataType* is used to represent a human-readable representation of an Enumeration. Its elements are described in Table 32. When this type is used in an array representing human-readable representations of an enumeration, each Value shall be unique in that array.

**Table 32 – EnumValueType Definition**

Name	Type	Description
EnumValueType	structure	
value	Int64	The Integer representation of an Enumeration.
displayName	LocalizedText	A human-readable representation of the Value of the Enumeration.
description	LocalizedText	A localized description of the enumeration value. This field can contain an empty string if no description is available.

Note that the *EnumValueType* has been defined with an Int64 Value to meet a variety of usages. When it is used to define the string representation of an Enumeration *DataType*, the value range is limited to Int32, because the Enumeration *DataType* is a subtype of Int32. OPC 10000-8 specifies other usages where the actual value might be between 8 and 64 Bit.

### 8.41 OptionSet

This abstract *DataType* is the base *DataType* for all *DataTypes* representing a bit mask. All *OptionSet DataTypes* representing bit masks shall inherit from this *DataType*. Its elements are described in Table 33.

**Table 33 – OptionSet Definition**

Name	Type	Description
OptionSet	structure	
value	ByteString	Array of bytes representing the bits in the option set. The length of the ByteString depends on the number of bits. The number of bytes may be larger than needed for the valid bits in the case of a spare allocation.
validBits	ByteString	Array of bytes with same size as value representing the valid bits in the value parameter. When the <i>Server</i> returns the value to the <i>Client</i> , the <i>validBits</i> provides information of which bits in the bit mask have a meaning. If a bit is 1 then the corresponding bit in the value is used by the <i>Server</i> . If it is set to a 0 it should be ignored as it has no meaning. When the <i>Client</i> passes the value to the <i>Server</i> , the <i>validBits</i> defines which bits should be written. Only those bits defined in <i>validBits</i> are changed in the bit mask, all others are not written.

The *DataType Nodes* representing concrete subtypes of the *OptionSet* shall have an *OptionSetValues Property* defined in Table 16.

### 8.42 Union

This abstract *DataType* is the base *DataType* for all union *DataTypes*. The *DataType* is a subtype of *Structure DataType*. All *DataTypes* inheriting from this *DataType* have special handling for the encoding as defined in OPC 10000-6. All union *DataTypes* shall inherit directly from this *DataType*.

### 8.43 DateString

This *Simple DataType* defines a value which is a day in the Gregorian calendar in string. Lexical representation of the string shall conform to calendar date defined in ISO 8601-2000.

NOTE: According to ISO 8601-2000, 'calendar date representations are in the form [YYYY-MM-DD]. [YYYY] indicates a four-digit year, 0000 through 9999. [MM] indicates a two-digit month of the year, 01 through 12. [DD] indicates a two-digit day of that month, 01 through 31. For example, "the 5th of April 1981" may be represented as either "1981-04-05" in the extended format or "19810405" in the basic format.'

NOTE: ISO 8601-2000 also allows for calendar dates to be written with reduced precision. For example, one may write "1981-04" to mean "1981 April", and one may simply write "1981" to refer to that year or "19" to refer to the century from 1900 to 1999 inclusive.

NOTE: Although ISO 8601-2000 allows both the YYYY-MM-DD and YYYYMMDD formats for complete calendar date representations, if the day [DD] is omitted then only the YYYY-MM format is allowed. By disallowing dates of the form YYYYMM, ISO 8601-2000 avoids confusion with the truncated representation YYMMDD (still often used).

### 8.44 DecimalString

This *Simple DataType* defines a value that represents a decimal number as a string. Lexical representation of the string shall conform to decimal type defined in W3C XML Schema Definition Language (XSD) 1.1 Part 2: *DataTypes*.

The *DecimalString* is a numeric string with an optional sign and decimal point.

### 8.45 DurationString

This *Simple DataType* defines a value that represents a duration of time as a string. It shall conform to duration as defined in ISO 8601-2000.

NOTE: According to ISO 8601-2000 'Durations are represented by the format P[n]Y[n]M[n]DT[n]H[n]M[n]S or P[n]W as shown to the right. In these representations, the [n] is replaced by the value for each of the date and time elements that follow the [n]. Leading zeros are not required, but the maximum number of digits for each element should be agreed to by the communicating parties. The capital letters P, Y, M, W, D, T, H, M, and S are designators for each of the date and time elements and are not replaced.

- P is the duration designator (historically called "period") placed at the start of the duration representation.

- *Y* is the year designator that follows the value for the number of years.
- *M* is the month designator that follows the value for the number of months.
- *W* is the week designator that follows the value for the number of weeks.
- *D* is the day designator that follows the value for the number of days.
- *T* is the time designator that precedes the time components of the representation.
- *H* is the hour designator that follows the value for the number of hours.
- *M* is the minute designator that follows the value for the number of minutes.
- *S* is the second designator that follows the value for the number of seconds.

For example, "P3Y6M4DT12H30M5S" represents a duration of "three years, six months, four days, twelve hours, thirty minutes, and five seconds". Date and time elements including their designator may be omitted if their value is zero, and lower order elements may also be omitted for reduced precision. For example, "P23DT23H" and "P4Y" are both acceptable duration representations.'

### 8.46 NormalizedString

This *Simple DataType* defines a string value that shall be normalized according to Unicode Annex 15, Version 7.0.0, Normalization Form C.

NOTE: Some Unicode characters have multiple equivalent binary representations consisting of sets of combining and/or composite Unicode characters. Unicode defines a process called normalization that returns one binary representation when given any of the equivalent binary representations of a character. The Win32 and the .NET Framework currently support normalization forms C, D, KC, and KD, as defined in Annex 15 of Unicode. *NormalizedString* uses Normalization Form C for all content, because this form avoids potential interoperability problems caused by the use of canonically equivalent, yet different, character sequences in document formats.

### 8.47 TimeString

This *Simple DataType* defines a value that represents a time as a string. It shall conform to time of day as defined in ISO 8601-2000.

NOTE: ISO 8601-2000 uses the 24-hour clock system. The *basic format* is [hh][mm][ss] and the *extended format* is [hh]:[mm]:[ss].

- [hh] refers to a zero-padded hour between 00 and 24 (where 24 is only used to notate midnight at the end of a calendar day).
- [mm] refers to a zero-padded minute between 00 and 59.
- [ss] refers to a zero-padded second between 00 and 60 (where 60 is only used to notate an added leap second).

So a time might appear as either "134730" in the *basic format* or "13:47:30" in the *extended format*.

It is also acceptable to omit lower order time elements for reduced accuracy: [hh]:[mm], [hh][mm] and [hh] are all used.

Midnight is a special case and can be referred to as both "00:00" and "24:00". The notation "00:00" is used at the beginning of a calendar day and is the more frequently used. At the end of a day use "24:00"

### 8.48 DataTypeDefinition

This abstract *DataType* is the base type for all *DataTypes* used to provide the meta data for custom *DataTypes* like *Structures and Enumerations*.

### 8.49 StructureDefinition

This *Structured DataType* is used to provide the meta data for a custom *Structure DataType*. It is derived from the *DataType DataTypeDefinition*. The *StructureDefinition* is formally defined in Table 34.



*StructureField* name and the *NamespaceIndex* of the *BrowseName* shall be the same as the *Structure DataType Node NamespaceIndex*.

### 8.52 EnumField

This *Structured DataType* is used to provide the metadata for a field of a custom *Enumeration* or *OptionSet DataType*. It is derived from the *DataType EnumValueType*. If used for an *OptionSet*, the corresponding *Value* in the base type contains the number of the bit associated with the field. The *EnumField* is formally defined in Table 37.

**Table 37 – EnumField Structure**

Name	Type	Description
EnumField	Structure	
name	String	A name for the field that is unique within the <i>EnumDefinition</i> .

### 8.53 AudioDataType

This abstract *DataType* defines a *ByteString* representing audio data. The audio stored in the *ByteString* could be formats like WAV or MP3 or any number of other audio formats. These formats are self-describing as part of the *ByteString* and are not specified in this specification.

### 8.54 Decimal

This *Simple DataType* defines a high-precision signed number. It consists of an arbitrary precision integer unscaled value and an integer scale. The scale is the inverse power of ten that is applied to the unscaled value.

### 8.55 PermissionType

This is a subtype of the *UInt32 DataType* with the *OptionSetValues Property* defined. It is used to define the permissions of a *Node*. The *PermissionType* is formally defined in Table 38.

**Table 38 – PermissionType Definition**

Name	Bit	Description
Browse	0	The <i>Client</i> is allowed to see the references to and from the <i>Node</i> . This implies that the <i>Client</i> is able to Read to <i>Attributes</i> other than the <i>Value</i> or the <i>RolePermissions Attribute</i> . This <i>Permission</i> is valid for all <i>NodeClasses</i> .
ReadRolePermissions	1	The <i>Client</i> is allowed to read the <i>RolePermissions Attribute</i> . This <i>Permission</i> is valid for all <i>NodeClasses</i> .
WriteAttribute	2	The <i>Client</i> is allowed to write to <i>Attributes</i> other than the <i>Value</i> , <i>Historizing</i> or <i>RolePermissions Attribute</i> if the <i>WriteMask</i> indicates that the <i>Attribute</i> is writeable. This bit affects the value of a <i>UserWriteMask Attribute</i> . This <i>Permission</i> is valid for all <i>NodeClasses</i> .
WriteRolePermissions	3	The <i>Client</i> is allowed to write to the <i>RolePermissions Attribute</i> if the <i>WriteMask</i> indicates that the <i>Attribute</i> is writeable. This bit affects the value of the <i>UserWriteMask Attribute</i> . This <i>Permission</i> is valid for all <i>NodeClasses</i> .
WriteHistorizing	4	The <i>Client</i> is allowed to write to the <i>Historizing Attributes</i> if the <i>WriteMask</i> indicates that the <i>Attribute</i> is writeable. This bit affects the value of the <i>UserWriteMask Attribute</i> . This <i>Permission</i> is only valid for <i>Variables</i> .
Read	5	The <i>Client</i> is allowed to read the <i>Value Attribute</i> . This bit affects the <i>CurrentRead</i> bit of the <i>UserAccessLevel Attribute</i> . This <i>Permission</i> is only valid for <i>Variables</i> .
Write	6	The <i>Client</i> is allowed to write the <i>Value Attribute</i> . This bit affects the <i>CurrentWrite</i> bit of the <i>UserAccessLevel Attribute</i> . This <i>Permission</i> is only valid for <i>Variables</i> .



ReadHistory	7	The <i>Client</i> is allowed to read the history associated with a <i>Node</i> . This bit affects the <i>HistoryRead</i> bit of the <i>UserAccessLevel Attribute</i> . This <i>Permission</i> is only valid for <i>Variables, Objects</i> or <i>Views</i> .
InsertHistory	8	The <i>Client</i> is allowed to insert the history associated with a <i>Node</i> . This bit affects the <i>HistoryWrite</i> bit of the <i>UserAccessLevel Attribute</i> . This <i>Permission</i> is only valid for <i>Variables, Objects</i> or <i>Views</i> .
ModifyHistory	9	The <i>Client</i> is allowed to modify the history associated with a <i>Node</i> . This bit affects the <i>HistoryWrite</i> bit of the <i>UserAccessLevel Attribute</i> . This <i>Permission</i> is only valid for <i>Variables, Objects</i> or <i>Views</i> .
DeleteHistory	10	The <i>Client</i> is allowed to delete the history associated with a <i>Node</i> . This bit affects the <i>HistoryWrite</i> bit of the <i>UserAccessLevel Attribute</i> . This <i>Permission</i> is only valid for <i>Variables, Objects</i> or <i>Views</i> .
ReceiveEvents	11	A <i>Client</i> only receives an <i>Event</i> if this bit is set on the <i>Node</i> identified by the <i>EventTypeId</i> field and on the <i>Node</i> identified by the <i>SourceNode</i> field. This <i>Permission</i> is only valid for <i>EventType Nodes</i> or <i>SourceNodes</i> .
Call	12	The <i>Client</i> is allowed to call the <i>Method</i> if this bit is set on the <i>Object</i> or <i>ObjectType Node</i> passed in the <i>Call</i> request and the <i>Method Instance</i> associated with that <i>Object</i> or <i>ObjectType</i> . This bit affects the <i>UserExecutable Attribute</i> when set on <i>Method Node</i> . This <i>Permission</i> is only valid for <i>Objects, ObjectType</i> or <i>Methods</i> .
AddReference	13	The <i>Client</i> is allowed to add references to the <i>Node</i> . This <i>Permission</i> is valid for all <i>NodeClasses</i> .
RemoveReference	14	The <i>Client</i> is allowed to remove references from the <i>Node</i> . This <i>Permission</i> is valid for all <i>NodeClasses</i> .
DeleteNode	15	The <i>Client</i> is allowed to delete the <i>Node</i> . This <i>Permission</i> is valid for all <i>NodeClasses</i> .
AddNode	16	The <i>Client</i> is allowed to add <i>Nodes</i> to the <i>Namespace</i> . This <i>Permission</i> is only used in the <i>DefaultRolePermissions</i> and <i>DefaultUserRolePermissions Properties</i> of a <i>NamespaceMetadata Object</i>
Reserved	17-31	These bits are reserved for use by OPC UA.

### 8.56 AccessRestrictionsType

This is a subtype of the *UInt16 DataType* with the *OptionSetValues Property* defined. It is used to define the access restrictions of a *Node*. The *AccessRestrictionsType* is formally defined in Table 39.

**Table 39 – AccessRestrictionsType Definition**

Name	Bit	Description
SigningRequired	0	The <i>Client</i> can only access the <i>Node</i> when using a <i>SecureChannel</i> which digitally signs all messages.
EncryptionRequired	1	The <i>Client</i> can only access the <i>Node</i> when using a <i>SecureChannel</i> which encrypts all messages.
SessionRequired	2	The <i>Client</i> cannot access the <i>Node</i> when using <i>SessionlessInvoke Service</i> invocation.

### 8.57 AccessLevelType

This is a subtype of the *Byte DataType* with the *OptionSetValues Property* defined. It is used to indicate how the *Value* of a *Variable* can be accessed (read/write) and if it contains current and/or historic data. The *AccessLevelType* is formally defined in Table 40.

**Table 40 – AccessLevelType Definition**

Name	Bit	Description
CurrentRead	0	Indicates if the current value is readable. It also indicates if the current value of the <i>Variable</i> is available. (0 means not readable, 1 means readable).
CurrentWrite	1	Indicates if the current value is writable. It also indicates if the current value of the <i>Variable</i> is available (0 means not writable, 1 means writable).
HistoryRead	2	Indicates if the history of the value is readable. It also indicates if the history of the <i>Variable</i> is available via the OPC UA <i>Server</i> . (0 means not readable, 1 means readable).
HistoryWrite	3	Indicates if the history of the value is writable It also indicates if the history of the <i>Variable</i> is available via the OPC UA <i>Server</i> . (0 means not writable, 1 means writable).
SemanticChange	4	This flag is set for <i>Properties</i> that define semantic aspects of the parent <i>Node</i> of the <i>Property</i> and where the <i>Property Value</i> , and thus the semantic, may change during operation. (0 means is not a semantic, 1 means is a semantic).
StatusWrite	5	Indicates if the current <i>StatusCode</i> of the value is writable (0 means only <i>StatusCode</i> Good is writable, 1 means any <i>StatusCode</i> is writable).
TimestampWrite	6	Indicates if the current <i>SourceTimestamp</i> is writable (0 means only null timestamps are writable, 1 means any timestamp value is writeable).
Reserved	7	Reserved for future use. Shall always be zero.

### 8.58 AccessLevelExType

This is a subtype of the *UInt32 DataType* with the *OptionSetValues Property* defined. It is used to indicate how the *Value* of a *Variable* can be accessed (read/write), if it contains current and/or historic data and its atomicity.

The *AccessLevelExType DataType* is an extended version of the *AccessLevelType DataType* and as such contains the 8 bits of the *AccessLevelType* as the first 8 bits.

The *NonatomicRead*, and *NonatomicWrite Fields* represent the atomicity of a *Variable*. In general Atomicity is expected of OPC UA read and write operations. These Fields are used by systems, in particular hard-realtime controllers, which can not ensure atomicity.

The *AccessLevelExType* is formally defined in Table 41.

**Table 41 – AccessLevelExType Definition**

Name	Bit	Description
	0:7	Formally defined by the <i>AccessLevelType</i> in Table 40.
NonatomicRead	8	Indicates non-atomicity for Read access (0 means that atomicity is assured).
NonatomicWrite	9	Indicates non-atomicity for Write access (0 means that atomicity is assured).
WriteFullArrayOnly	10	Indicates if Write of <i>IndexRange</i> is supported. (0 means Write of <i>IndexRange</i> is supported)
	11:31	Reserved for future use. Shall always be zero.

### 8.59 EventNotifierType

This is a subtype of the *Byte DataType* with the *OptionSetValues Property* defined. It is used to indicate if a *Node* can be used to subscribe to *Events* or read / write historic *Events*.

The *EventNotifierType* is formally defined in Table 42.

**Table 42 – EventNotifierType Definition**

Name	Bit	Description
SubscribeTo Events	0	Indicates if it can be used to subscribe to <i>Events</i> (0 means cannot be used to subscribe to <i>Events</i> , 1 means can be used to subscribe to <i>Events</i> ).
	1	Reserved for future use. Shall always be zero.
HistoryRead	2	Indicates if the history of the <i>Events</i> is readable. (0 means not readable, 1 means readable).
HistoryWrite	3	Indicates if the history of the <i>Events</i> is writable. (0 means not writable, 1 means writable).
	4:7	Reserved for future use. Shall always be zero.

**8.60 AttributeWriteMask**

This is a subtype of the *UInt32 DataType* with the *OptionSetValues Property* defined. It is used to define the *Attribute* access restrictions of a *Node*. The *AttributeWriteMask* is formally defined in Table 43.

If a bit is set to 0, it means the *Attribute* is not writable. If a bit is set to 1, it means it is writable. If a *Node* does not support a specific *Attribute*, the corresponding bit has to be set to 0.

**Table 43 – Bit mask for WriteMask and UserWriteMask**

Field	Bit	Description
AccessLevel	0	Indicates if the AccessLevel Attribute is writable.
ArrayDimensions	1	Indicates if the ArrayDimensions Attribute is writable.
BrowseName	2	Indicates if the BrowseName Attribute is writable.
ContainsNoLoops	3	Indicates if the ContainsNoLoops Attribute is writable.
DataType	4	Indicates if the DataType Attribute is writable.
Description	5	Indicates if the Description Attribute is writable.
DisplayName	6	Indicates if the DisplayName Attribute is writable.
EventNotifier	7	Indicates if the EventNotifier Attribute is writable.
Executable	8	Indicates if the Executable Attribute is writable.
Historizing	9	Indicates if the Historizing Attribute is writable.
InverseName	10	Indicates if the InverseName Attribute is writable.
IsAbstract	11	Indicates if the IsAbstract Attribute is writable.
MinimumSamplingInterval	12	Indicates if the MinimumSamplingInterval Attribute is writable.
NodeClass	13	Indicates if the NodeClass Attribute is writable.
NodeId	14	Indicates if the NodeId Attribute is writable.
Symmetric	15	Indicates if the Symmetric Attribute is writable.
UserAccessLevel	16	Indicates if the UserAccessLevel Attribute is writable.
UserExecutable	17	Indicates if the UserExecutable Attribute is writable.
UserWriteMask	18	Indicates if the UserWriteMask Attribute is writable.
ValueRank	19	Indicates if the ValueRank Attribute is writable.
WriteMask	20	Indicates if the WriteMask Attribute is writable.
ValueForVariableType	21	Indicates if the <i>Value Attribute</i> is writable for a <i>VariableType</i> . It does not apply for <i>Variables</i> since this is handled by the <i>AccessLevel</i> and <i>UserAccessLevel Attributes</i> for the <i>Variable</i> . For <i>Variables</i> this bit shall be set to 0.
DataTypeDefinition	22	Indicates if the DataTypeDefinition Attribute is writable.
RolePermissions	23	Indicates if the RolePermissions Attribute is writable.
AccessRestrictions	24	Indicates if the AccessRestrictions Attribute is writable.
AccessLevelEx	25	Indicates if the AccessLevelEx Attribute is writable.
Reserved	26:31	Reserved for future use. Shall always be zero.

**9 Standard EventTypes**

**9.1 General**

The remainder of 9 defines *EventTypes*. Their representation in the *AddressSpace* is specified in OPC 10000-5. Other parts of this series of standards may specify additional *EventTypes*. Figure 29 informally describes the hierarchy of these *EventTypes*.

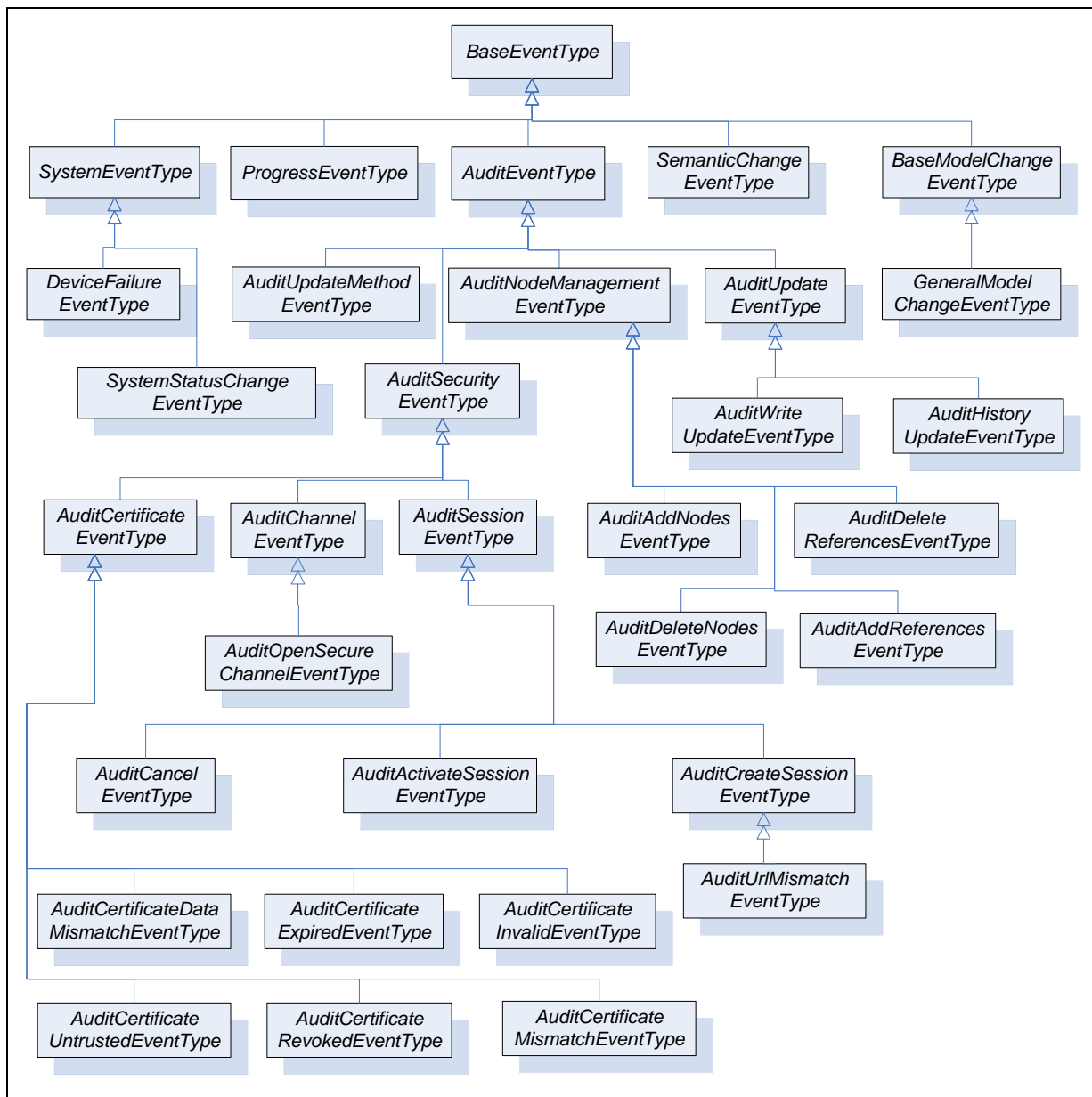

Figure 29 – Standard EventType Hierarchy

### 9.2 BaseEventType

The *BaseEventType* defines all general characteristics of an *Event*. All other *EventTypes* derive from it. There is no other semantic associated with this type.

### 9.3 SystemEventType

*SystemEvents* are *Events* of *SystemEventType* that are generated as a result of some *Event* that occurs within the *Server* or by a system that the *Server* is representing.

### 9.4 ProgressEventType

*ProgressEvents* are *Events* of *ProgressEventType* that are generated to identify the progress of an operation. An operation can be a service call or something application specific like a program execution.

### 9.5 AuditEventType

*AuditEvents* are *Events* of *AuditEventType* that are generated as a result of an action taken on the *Server* by a *Client* of the *Server*. For example, in response to a *Client* issuing a write to a

*Variable*, the *Server* would generate an *AuditEvent* describing the *Variable* as the source and the user and *Client* session as the initiators of the *Event*.

Figure 30 illustrates the defined behaviour of an OPC UA *Server* in response to an auditable action request. If the action is accepted, then an action *AuditEvent* is generated and processed by the *Server*. If the action is not accepted due to security reasons, a security *AuditEvent* is generated and processed by the *Server*. The *Server* may involve the underlying device or system in the process but it is the *Server's* responsibility to provide the *Event* to any interested *Clients*. *Clients* are free to subscribe to *Events* from the *Server* and will receive the *AuditEvents* in response to normal Publish requests.

All action requests include a human readable *AuditEntryId*. The *AuditEntryId* is included in the *AuditEvent* to allow human readers to correlate an *Event* with the initiating action. The *AuditEntryId* typically contains who initiated the action and from where it was initiated.

The *Server* may elect to optionally persist the *AuditEvents* in addition to the mandatory *Event Subscription* delivery to *Clients*.

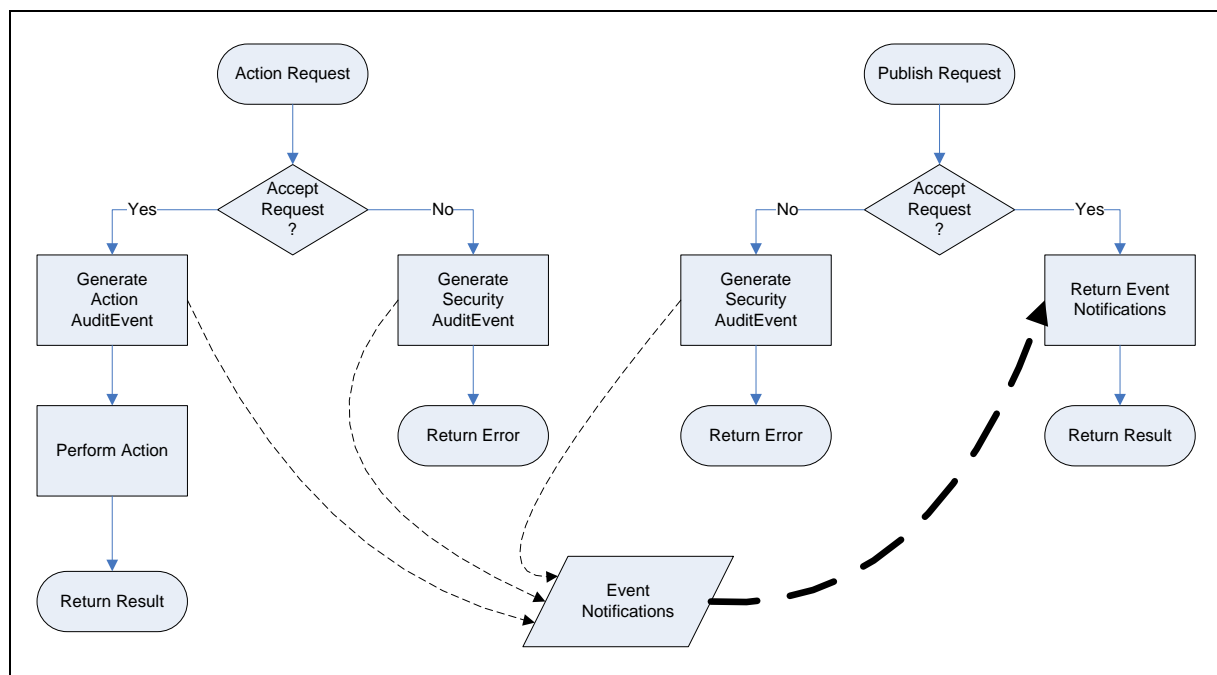

**Figure 30 – Audit Behaviour of a Server**

Figure 31 illustrates the expected behaviour of an aggregating *Server* in response to an auditable action request. This use case involves the aggregating *Server* passing on the action to one of its aggregated *Servers*. The general behaviour described above is extended by this behaviour and not replaced. That is, the request could fail and generate a security *AuditEvent* within the aggregating *Server*. The normal process is to pass the action down to an aggregated *Server* for processing. The aggregated *Server* will, in turn, follow this behaviour or the general behaviour and generate the appropriate *AuditEvents*. The aggregating *Server* periodically issues publish requests to the aggregated *Servers*. These collected *Events* are merged with self-generated *Events* and made available to subscribing *Clients*. If the aggregating *Server* supports the optional persisting of *AuditEvent*, then the collected *Events* are persisted along with locally-generated *Events*.

The aggregating *Server* may map the authenticated user account making the request to one of its own accounts when passing on the request to an aggregated *Server*. It shall, however, preserve the *AuditEntryId* by passing it on as received. The aggregating *Server* may also generate its own *AuditEvent* for the request prior to passing it on to the aggregated *Server*, in particular, if the aggregating *Server* needs to break a request into multiple requests that are each directed to separate aggregated *Servers* or if part of a request is denied due to security on the aggregating *Server*.

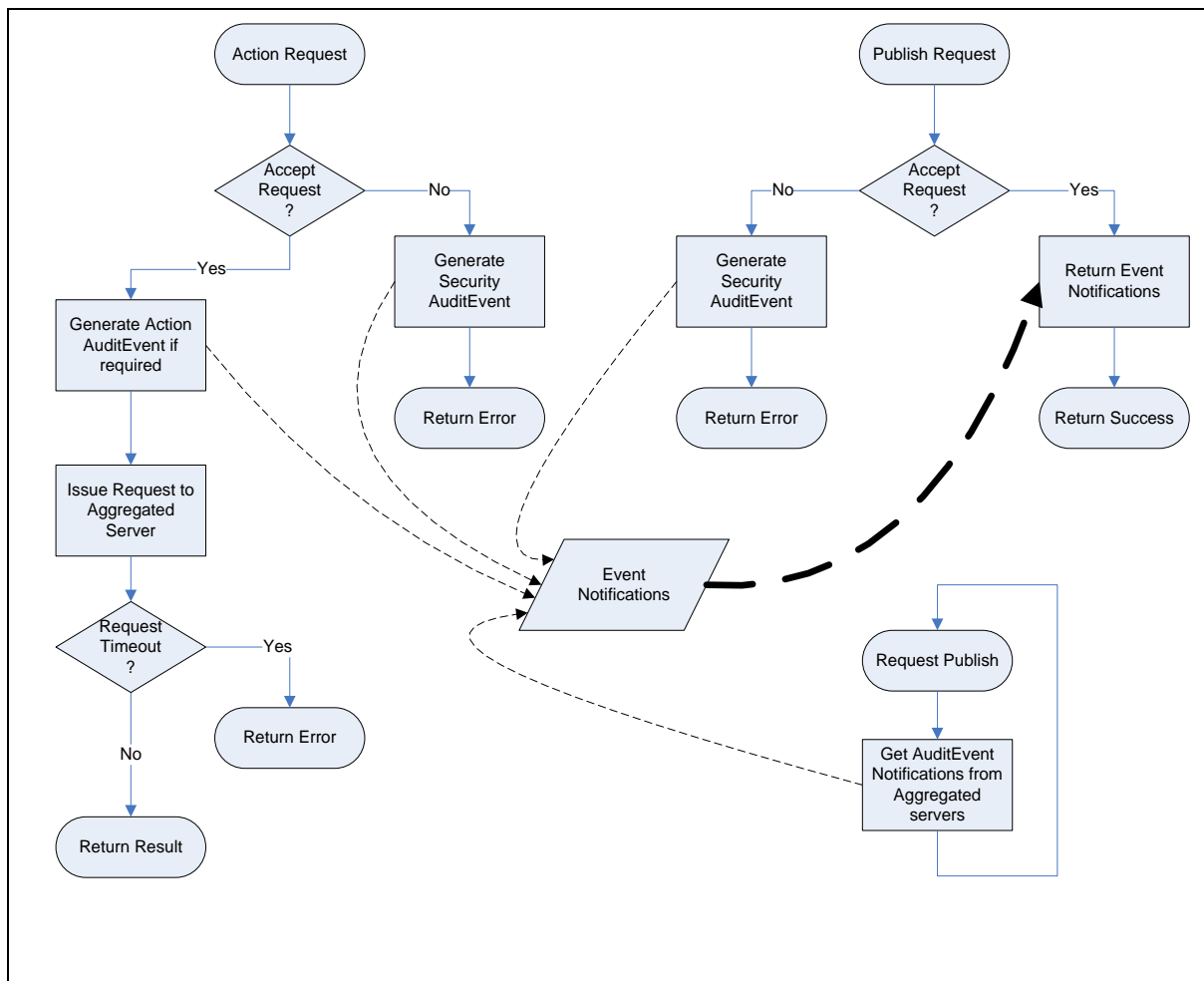

**Figure 31 – Audit Behaviour of an Aggregating Server**

## 9.6 AuditSecurityEventType

This is a subtype of *AuditEventType* and is used only for categorization of security-related *Events*. This type follows all behaviour of its parent type.

## 9.7 AuditChannelEventType

This is a subtype of *AuditSecurityEventType* and is used for categorization of security-related *Events* from the *SecureChannel Service Set* defined in OPC 10000-4.

## 9.8 AuditOpenSecureChannelEventType

This is a subtype of *AuditChannelEventType* and is used for *Events* generated from calling the *OpenSecureChannel Service* defined in OPC 10000-4.

## 9.9 AuditSessionEventType

This is a subtype of *AuditSecurityEventType* and is used for categorization of security-related *Events* from the *Session Service Set* defined in OPC 10000-4.

## 9.10 AuditCreateSessionEventType

This is a subtype of *AuditSessionEventType* and is used for *Events* generated from calling the *CreateSession Service* defined in OPC 10000-4.

## 9.11 AuditUrlMismatchEventType

This is a subtype of *AuditCreateSessionEventType* and is used for *Events* generated from calling the *CreateSession Service* defined in OPC 10000-4 if the *EndpointUrl* used in the service call does not match the *Server's HostNames* (see OPC 10000-4 for details).

### 9.12 AuditActivateSessionEventType

This is a subtype of *AuditSessionEventType* and is used for *Events* generated from calling the *ActivateSession Service* defined in OPC 10000-4.

### 9.13 AuditCancelEventType

This is a subtype of *AuditSessionEventType* and is used for *Events* generated from calling the *Cancel Service* defined in OPC 10000-4.

### 9.14 AuditCertificateEventType

This is a subtype of *AuditSecurityEventType* and is used only for categorization of Certificate related *Events*. This type follows all behaviours of its parent type. These *AuditEvents* will be generated for Certificate errors in addition to other *AuditEvents* related to service calls.

### 9.15 AuditCertificateDataMismatchEventType

This is a subtype of *AuditCertificateEventType* and is used only for categorization of Certificate related *Events*. This type follows all behaviours of its parent type. This *AuditEvent* is generated if the *HostName* in the URL used to connect to the *Server* is not the same as one of the *HostNames* specified in the Certificate or if the *Application* and *Software Certificates* contain an *application* or *product URI* that does not match the *URI* specified in the *ApplicationDescription* provided with the Certificate. For more details on Certificates see OPC 10000-4.

### 9.16 AuditCertificateExpiredEventType

This is a subtype of *AuditCertificateEventType* and is used only for categorization of Certificate related *Events*. This type follows all behaviours of its parent type. This *AuditEvent* is generated if the current time is outside the validity period's start date and end date.

### 9.17 AuditCertificateInvalidEventType

This is a subtype of *AuditCertificateEventType* and is used only for categorization of Certificate related *Events*. This type follows all behaviours of its parent type. This *AuditEvent* is generated if the certificate structure is invalid or if the Certificate has an invalid signature.

### 9.18 AuditCertificateUntrustedEventType

This is a subtype of *AuditCertificateEventType* and is used only for categorization of Certificate related *Events*. This type follows all behaviours of its parent type. This *AuditEvent* is generated if the Certificate is not trusted, that is, if the *Issuer Certificate* is unknown.

### 9.19 AuditCertificateRevokedEventType

This is a subtype of *AuditCertificateEventType* and is used only for categorization of Certificate related *Events*. This type follows all behaviours of its parent type. This *AuditEvent* is generated if a Certificate has been revoked or if the revocation list is not available (i.e. a network interruption prevents the Application from accessing the list).

### 9.20 AuditCertificateMismatchEventType

This is a subtype of *AuditCertificateEventType* and is used only for categorization of Certificate related *Events*. This type follows all behaviours of its parent type. This *AuditEvent* is generated if a Certificate set of uses does not match the requested use for the Certificate (i.e. *Application*, *Software* or *Certificate Authority*).

### 9.21 AuditNodeManagementEventType

This is a subtype of *AuditEventType* and is used for categorization of node management related *Events*. This type follows all behaviours of its parent type.

### 9.22 AuditAddNodesEventType

This is a subtype of *AuditNodeManagementEventType* and is used for *Events* generated from calling the *AddNodes Service* defined in OPC 10000-4.

### 9.23 AuditDeleteNodesEventType

This is a subtype of *AuditNodeManagementEventType* and is used for *Events* generated from calling the *DeleteNodes Service* defined in OPC 10000-4.

### 9.24 AuditAddReferencesEventType

This is a subtype of *AuditNodeManagementEventType* and is used for *Events* generated from calling the *AddReferences Service* defined in OPC 10000-4.

### 9.25 AuditDeleteReferencesEventType

This is a subtype of *AuditNodeManagementEventType* and is used for *Events* generated from calling the *DeleteReferences Service* defined in OPC 10000-4.

### 9.26 AuditUpdateEventType

This is a subtype of *AuditEventType* and is used for categorization of update related *Events*. This type follows all behaviours of its parent type.

### 9.27 AuditWriteUpdateEventType

This is a subtype of *AuditUpdateEventType* and is used for categorization of write update related *Events*. This type follows all behaviours of its parent type.

### 9.28 AuditHistoryUpdateEventType

This is a subtype of *AuditUpdateEventType* and is used for categorization of history update related *Events*. This type follows all behaviours of its parent type.

### 9.29 AuditUpdateMethodEventType

This is a subtype of *AuditEventType* and is used for categorization of *Method* related *Events*. This type follows all behaviours of its parent type.

### 9.30 DeviceFailureEventType

A *DeviceFailureEvent* is an *Event* of *DeviceFailureEventType* that indicates a failure in a device of the underlying system.

### 9.31 SystemStatusChangeEvent

A *SystemStatusChangeEvent* is an *Event* of *SystemStatusChangeEvent* that indicates a status change in a system. For example, if the status indicates an underlying system is not running, then a *Client* cannot expect any *Events* from the underlying system. A *Server* can identify its own status changes using this *EventType*.

### 9.32 ModelChangeEvents

#### 9.32.1 General

*ModelChangeEvents* are generated to indicate a change of the *AddressSpace* structure. The change may consist of adding or deleting a *Node* or *Reference*. Although the relationship of a *Variable* or *VariableType* to its *DataType* is not modelled using *References*, changes to the *DataType Attribute* of a *Variable* or *VariableType* are also considered as model changes and therefore a *ModelChangeEvent* is generated if the *DataType Attribute* changes.

#### 9.32.2 NodeVersion Property

There is a correlation between *ModelChangeEvents* and the *NodeVersion Property* of *Nodes*. Every time a *ModelChangeEvent* is issued for a *Node*, its *NodeVersion* shall be changed, and every time the *NodeVersion* is changed, a *ModelChangeEvent* shall be generated. A *Server* shall support both the *ModelChangeEvent* and the *NodeVersion Property* or neither, but never only one of the two mechanisms.

This relation also implies that only those *Nodes* of the *AddressSpace* having a *NodeVersion* shall trigger a *ModelChangeEvent*. Other *Nodes* shall not trigger a *ModelChangeEvent*.



### 9.32.3 Views

A *ModelChangeEvent* is always generated in the context of a *View*, including the default *View* where the whole *AddressSpace* is considered. Therefore the only *Notifiers* which report the *ModelChangeEvents* are *View Nodes* and the *Server Object* representing the default *View*. Each action generating a *ModelChangeEvent* may lead to several *Events* since it may affect different *Views*. If, for example, a *Node* was deleted from the *AddressSpace*, and this *Node* was also contained in a *View "A"*, there would be one *Event* having the *AddressSpace* as context and another having the *View "A"* as context. If a *Node* would only be removed from *View "A"*, but still exists in the *AddressSpace*, it would generate only a *ModelChangeEvent* for *View "A"*.

If a *Client* does not want to receive duplicates of changes then it shall use the filter mechanisms of the *Event* subscription to filter only for the default *View* and suppress the *ModelChangeEvents* having other *Views* as the context.

When a *ModelChangeEvent* is issued on a *View* and the *View* supports the *ViewVersion Property*, then the *ViewVersion* shall be updated.

### 9.32.4 Event Compression

An implementation is not required to issue an *Event* for every update as it occurs. An OPC UA *Server* may be capable of grouping a series of transactions or simple updates into a larger unit. This series may constitute a logical grouping or a temporal grouping of changes. A single *ModelChangeEvent* may be issued after the last change of the series, to cover all of the changes. This is referred to as *Event compression*. A change in the *NodeVersion* and the *ViewVersion* may thus reflect a group of changes and not a single change.

### 9.32.5 BaseModelChangeEvent

*BaseModelChangeEvents* are *Events* of the *BaseModelChangeEvent*. The *BaseModelChangeEvent* is the base type for *ModelChangeEvents* and does not contain information about the changes but only indicates that changes occurred. Therefore the *Client* shall assume that any or all of the *Nodes* may have changed.

### 9.32.6 GeneralModelChangeEvent

*GeneralModelChangeEvents* are *Events* of the *GeneralModelChangeEvent*. The *GeneralModelChangeEvent* is a subtype of the *BaseModelChangeEvent*. It contains information about the *Node* that was changed and the action that occurred to cause the *ModelChangeEvent* (e.g. add a *Node*, delete a *Node*, etc.). If the affected *Node* is a *Variable* or *Object*, then the *TypeDefinitionNode* is also present.

To allow *Event* compression, a *GeneralModelChangeEvent* contains an array of changes.

### 9.32.7 Guidelines for ModelChangeEvents

Two types of *ModelChangeEvents* are defined: the *BaseModelChangeEvent* that does not contain any information about the changes and the *GeneralModelChangeEvent* that identifies the changed *Nodes* via an array. The precision used depends on both the capability of the OPC UA *Server* and the nature of the update. An OPC UA *Server* may use either *ModelChangeEvent* type depending on circumstances. It may also define subtypes of these *EventTypes* adding additional information.

To ensure interoperability, the following guidelines for *Events* should be observed.

- If the array of the *GeneralModelChangeEvent* is present, then it should identify every *Node* that has changed since the preceding *ModelChangeEvent*.
- The OPC UA *Server* should emit exactly one *ModelChangeEvent* for an update or series of updates. It should not issue multiple types of *ModelChangeEvent* for the same update.
- Any *Client* that responds to *ModelChangeEvents* should respond to any *Event* of the *BaseModelChangeEvent* including its subtypes like the *GeneralModelChangeEvent*.

If a *Client* is not capable of interpreting additional information of the subtypes of the *BaseModelChangeEvent* type, it should treat *Events* of these types the same way as *Events* of the *BaseModelChangeEvent* type.

### **9.33 SemanticChangeEvent**

#### **9.33.1 General**

*SemanticChangeEvents* are *Events* of *SemanticChangeEvent* type that are generated to indicate a change of the *AddressSpace* semantics. The change consists of a change to the *Value Attribute* of a *Property*.

The *SemanticChangeEvent* contains information about the *Node* owning the *Property* that was changed. If this is a *Variable* or *Object*, the *TypeDefinitionNode* is also present.

The *SemanticChange* bit of the *AccessLevel Attribute* of a *Property* indicates whether changes of the *Property* value are considered for *SemanticChangeEvents* (see 5.6.2).

#### **9.33.2 ViewVersion and NodeVersion Properties**

The *ViewVersion* and *NodeVersion Properties* do not change due to the publication of a *SemanticChangeEvent*.

#### **9.33.3 Views**

*SemanticChangeEvents* are handled in the context of a *View* the same way as *ModelChangeEvents*. This is defined in 9.32.3.

#### **9.33.4 Event Compression**

*SemanticChangeEvents* can be compressed the same way as *ModelChangeEvents*. This is defined in 9.32.4.

## Annex A (informative)

### How to use the Address Space Model

#### A.1 Overview

Annex A points out some general considerations on how the Address Space Model can be used. Annex A is for information only, that is, each *Server* vendor can model its data in the appropriate way that fits its needs. However, it gives some hints the *Server* vendor may consider.

Typically OPC UA *Servers* will offer data provided by an underlying system like a device, a configuration database, an OPC COM *Server*, etc. Therefore the modelling of the data depends on the model of the underlying system as well as the requirements of the *Clients* accessing the OPC UA *Server*. It is also expected that companion specifications will be developed on top of OPC UA with additional rules on how to model the data. However, the remainder of Annex A will give some general considerations about the different concepts of OPC UA to model data and when they should be used, and when not.

OPC 10000-5:–, Annex A, provides an overview of the design decisions made when modelling the information about the *Server* defined in OPC 10000-5.

#### A.2 Type definitions

Type definitions should be used whenever it is expected that the type information may be used more than once in the same system or for interoperability between different systems supporting the same type definitions.

#### A.3 ObjectTypes

Subclause 5.5.1 states: “*Objects* are used to represent systems, system components, real-world objects, and software objects.” Therefore *ObjectTypes* should be used if a type definition of those *ObjectTypes* is useful (see A.2).

From a more abstract point of view *Objects* are used to group *Variables* and other *Objects* in the *AddressSpace*. Therefore *ObjectTypes* should be used when some common structures/groups of *Objects* and/or *Variables* should be described. *Clients* can use this knowledge to program against the *ObjectType* structure and use the *TranslateBrowsePathsToNodeIds Service* defined in OPC 10000-4 on the instances.

Simple objects only having one value (e.g. a simple heat sensor) can also be modelled as *VariableTypes*. However, extensibility mechanisms should be considered (e.g. a complex heat sensor subtype could have several values) and whether that object should be exposed as an object in the *Client*'s GUI or just as a value. Whenever a modeller is in doubt as to which solution to use the *ObjectType* having one *Variable* should be preferred.

#### A.4 VariableTypes

##### A.4.1 General

*VariableTypes* are only used for *DataVariables*<sup>1</sup> and should be used when there are several *Variables* having the same semantic (e.g. set point). It is not necessary to define a *VariableType* that only reflects the *DataTypes* of a *Variable*, e.g. an “*Int32VariableType*”.

##### A.4.2 Properties or DataVariables

Besides the semantic differences of *Properties* and *DataVariables* described in Clause 4 there are also syntactical differences. A *Property* is identified by its *BrowseName*, that is, if *Properties*

---

<sup>1</sup> *VariableTypes* other than the *PropertyType* which is used for all *Properties*.

having the same semantic are used several times, they should always have the same *BrowseName*. The same semantic of *DataVariables* is captured in the *VariableType*.

If it is not clear which concept to use based on the semantic described in Clause 4, then the different syntax can help. The following points identify when it shall be a *DataVariable*.

- If it is a complex *Variable* or it should contain additional information in the form of *Properties*.
- If the type definition may be refined (subtyping).
- If the type definition should be made available so the *Client* can use the *AddNodes Service* defined in OPC 10000-4 to create new instances of the type definition.
- If it is a component of a complex *Variable* exposing a part of the value of the complex *Variable*.

#### A.4.3 Many Variables and / or structured DataTypes

When structured data structures should be made available to the *Client* there are basically three different approaches:

- a) Create several simple *Variables* using simple *DataTypes* always reflecting parts of the simple structure. *Objects* are used to group the *Variables* according to the structure of the data.
- b) Create a structured *DataType* and a simple *Variable* using this *DataType*.
- c) Create a structured *DataType* and a complex *Variable* using this *DataType* and also exposing the structured data structure as *Variables* of the complex *Variable* using simple *DataTypes*.

The advantages of the first approach are that the complex structure of the data is visible in the *AddressSpace*. A generic *Client* can easily access the data without knowledge of user-defined *DataTypes* and the *Client* can access individual parts of the structured data. The disadvantages of the first approach are that accessing the individual data does not provide any transactional context and for a specific *Client* the *Server* first has to convert the data and the *Client* has to convert the data, again, to get the data structure the underlying system provides.

The advantages of the second approach are, that the data is accessed in a transactional context and the structured *DataType* can be constructed in a way that the *Server* does not have to convert the data and can pass directly to the specific *Client* that can directly use them. The disadvantages are that the generic *Client* might not be able to access and interpret the data or has at least the burden to read the *DataTypeDefintion* to interpret the data. The structure of the data is not visible in the *AddressSpace*; additional *Properties* describing the data structure cannot be added to the adequate places since they do not exist in the *AddressSpace*. Individual parts of the data cannot be read without accessing the whole data structure.

The third approach combines the other two approaches. Therefore a specific *Client* can access data in its native format in a transactional context, whereas a generic *Client* can access simple *DataTypes* of the components of the complex *Variable*. The disadvantage is that the *Server* must be able to provide the native format and also interpret it to be able to provide the information in simple *DataTypes*.

It is recommended to use the first approach. When a transactional context is needed or the *Client* should be able to get a large amount of data instead of subscribing to several individual values, then the third approach is suitable. However, the *Server* might not always have the knowledge to interpret the structured data of the underlying system and therefore has to use the second approach just passing the data to the specific *Client* who is able to interpret the data.

#### A.5 Views

*Server*-defined *Views* can be used to present an excerpt of the *AddressSpace* suitable for a special class of *Clients*, for example maintenance *Clients*, engineering *Clients*, etc. The *View* only provides the information needed for the purpose of the *Client* and hides unnecessary information.

## A.6 Methods

*Methods* should be used whenever some input is expected and the *Server* delivers a result. One should avoid using *Variables* to write the input values and other *Variables* to get the output results as it was necessary to do in OPC COM since there was no concept of a *Method* available. However, a simple OPC COM wrapper might not be able to do this.

*Methods* can also be used to trigger some execution in the *Server* that does not require input and / or output parameters.

Global *Methods*, that is, *Methods* that cannot directly be assigned to a special *Object*, should be assigned to the *Server Object* defined in OPC 10000-5.

## A.7 Defining ReferenceTypes

Defining new *ReferenceTypes* should only be done if the predefined *ReferenceTypes* are not suitable. Whenever a new *ReferenceType* is defined, the most appropriate *ReferenceType* should be used as its supertype.

It is expected that *Servers* will have new defined hierarchical *ReferenceTypes* to expose different hierarchies, and new non-hierarchical *References* to expose relationships between *Nodes* in the *AddressSpace*.

## A.8 Defining ModellingRules

New *ModellingRules* have to be defined if the predefined *ModellingRules* are not appropriate for the model exposed by the *Server*.

Depending on the model used by the underlying system the *Server* may need to define new *ModellingRules*, since the OPC UA *Server* may only pass the data to the underlying system and this system may use its own internal rules for instantiation, subtyping, etc.

Beside this, the predefined *ModellingRules* might not be sufficient to specify the required behaviour for instantiation and subtyping.

## Annex B (informative)

### OPC UA Meta Model in UML

#### B.1 Background

The OPC UA Meta Model (the OPC UA Address Space Model) is represented by UML classes and UML objects marked with the stereotype <<TypeExtension>>. Those stereotyped UML objects represent *DataTypes* or *ReferenceTypes*. The domain model can contain user-defined *ReferenceTypes* and *DataTypes*, also marked as <<TypeExtension>>. In addition, the domain model contains *ObjectTypes*, *VariableTypes* etc. represented as UML objects (see Figure B.1).

The OPC Foundation specifies not only the OPC UA Meta Model, but also defines some *Nodes* to organise the *AddressSpace* and to provide information about the *Server* as specified in OPC 10000-5.

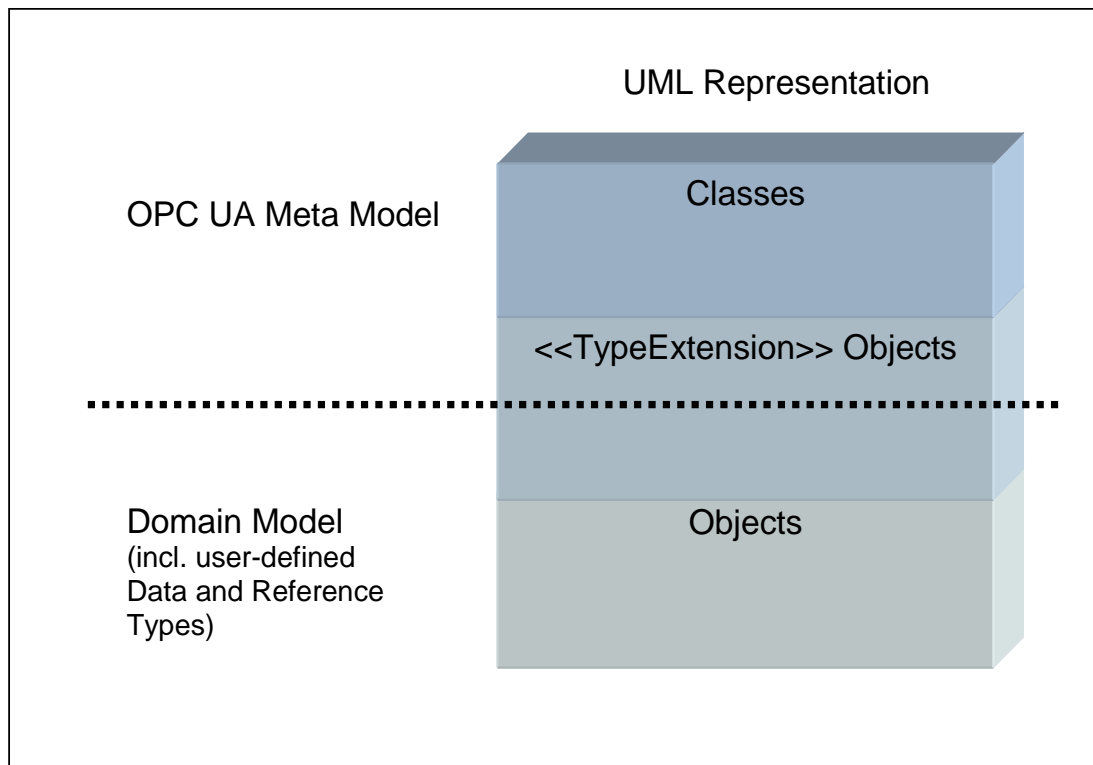
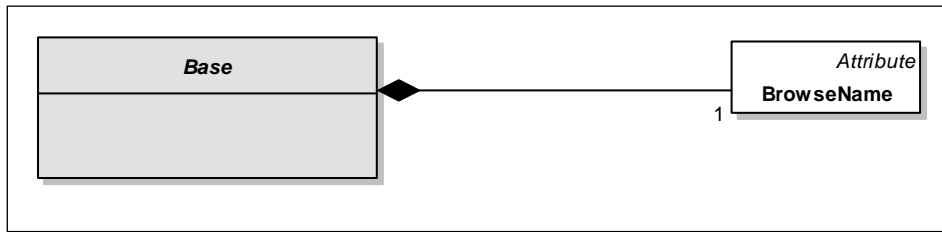

Figure B.1 – Background of OPC UA Meta Model

#### B.2 Notation

An example of a UML class representing the OPC UA concept *Base* is given in the UML class diagram in Figure B.2. OPC Attributes inherit from the abstract class *Attribute* and have a value identifying their data type. They are composed of a *Node* which is either optional (0..1) or required (1), such as *BrowseName* to *Base* in Figure B.2.



**Figure B.2 – Notation (I)**

UML object diagrams are used to display <<TypeExtension>> objects (e.g. *HasComponent* in Figure B.3). In object diagrams, OPC *Attributes* are represented as UML attributes without data types and marked with the stereotype <<Attribute>>, like *InverseName* in the UML object *HasComponent*. They have values, like *InverseName = ComponentOf* for *HasComponent*. To keep the object diagrams simple, not all *Attributes* are shown (e.g. the *NodeId* of *HasComponent*).

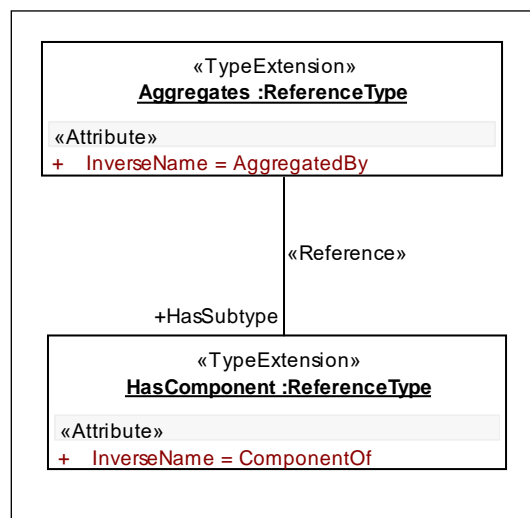

**Figure B.3 – Notation (II)**

OPC *References* are represented as UML associations marked with the stereotype <<Reference>>. If a particular *ReferenceType* is used, its name is used as the role name, identifying the direction of the *Reference* (e.g. *Aggregates* has the subtype *HasComponent*). For simplicity, the inverse role name is not shown (in the example *SubtypeOf*). When no role name is provided, it means that any *ReferenceType* can be used (only valid for class diagrams).

There are some special *Attributes* in OPC UA containing a *NodeId* and thereby referencing another *Node*. Those *Attributes* are represented as associations marked with the stereotype <<Attribute>>. The name of the *Attribute* is displayed as the role name of the *TargetNode*.

The value of the OPC *Attribute BrowseName* is represented by the UML object name, for example the *BrowseName* of the UML object *HasComponent* in Figure B.3 is “HasComponent”.

To highlight the classes explained in a class diagram, they are marked in grey (e.g. *Base* in Figure B.2). Only those classes have all of their relationships to other classes and attributes shown in the diagram. For the other classes, we provide only those attributes and relationships needed to understand the main classes of the diagram.

### B.3 Meta Model

NOTE: Other parts of this series of standards can extend the OPC UA Meta Model by adding *Attributes* and defining new *ReferenceTypes*.

#### B.3.1 Base

Base is shown in Figure B.4.

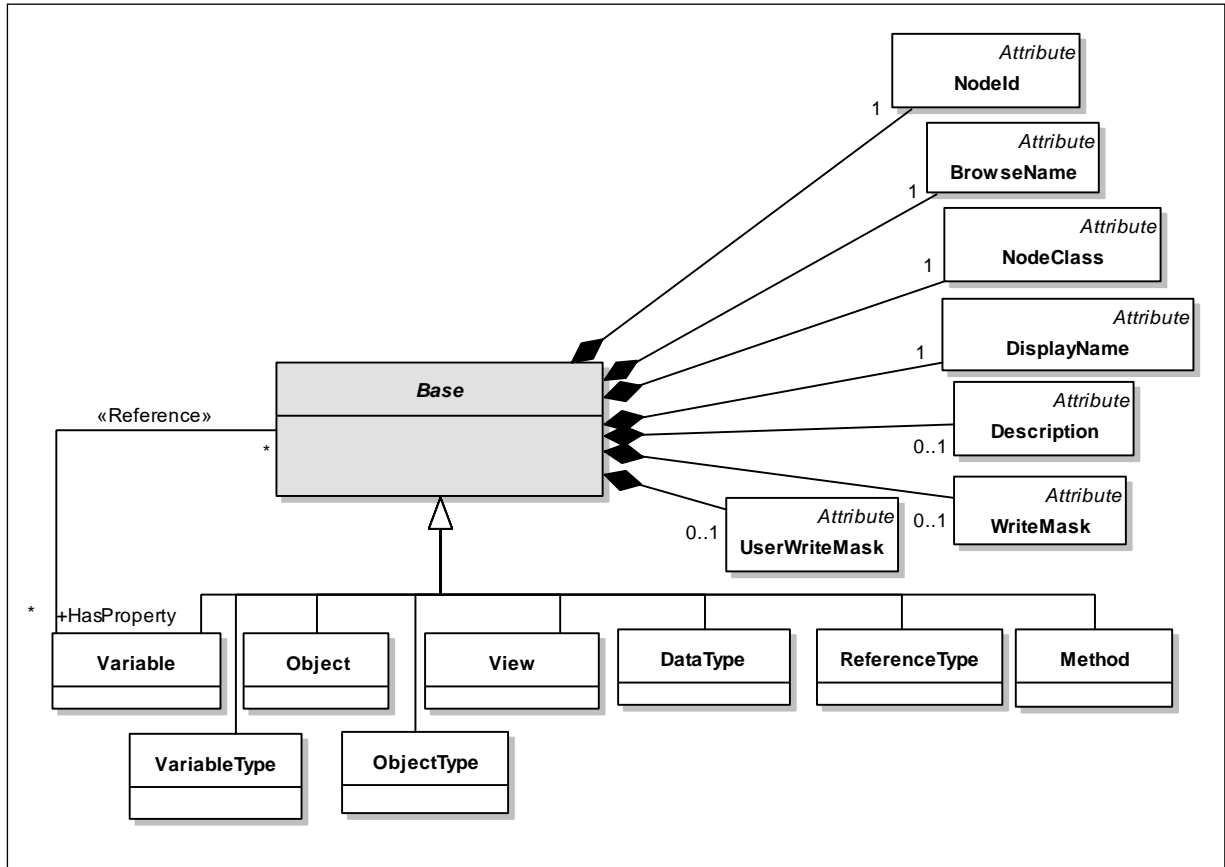

Figure B.4 – Base

### B.3.2 ReferenceType

ReferenceType is shown in Figure B.5 and predefined ReferenceTypes in Figure B.6.

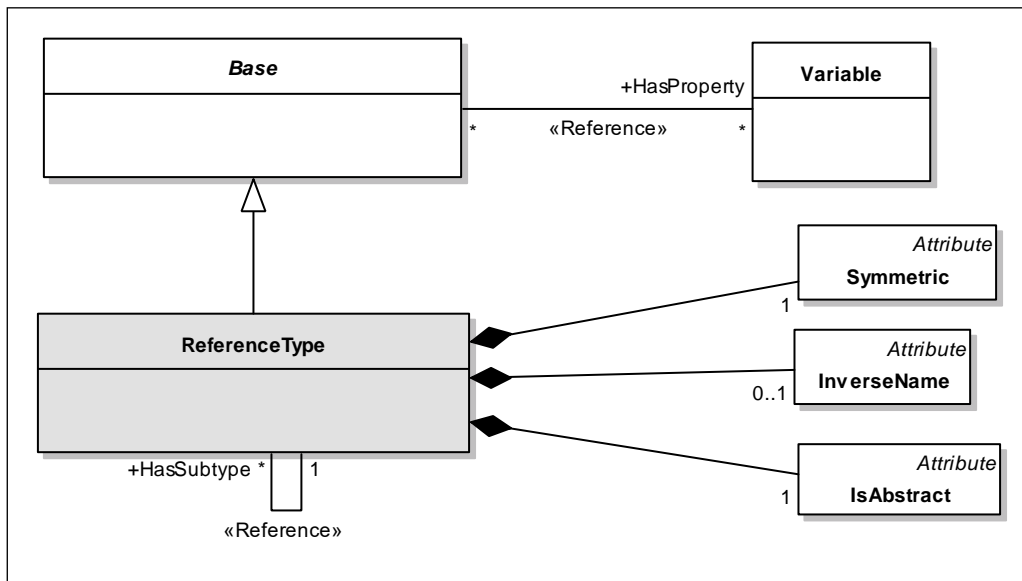

Figure B.5 – Reference and ReferenceType

If *Symmetric* is “false” and *IsAbstract* is “false” an *InverseName* shall be provided.



### B.3.3 Predefined ReferenceTypes

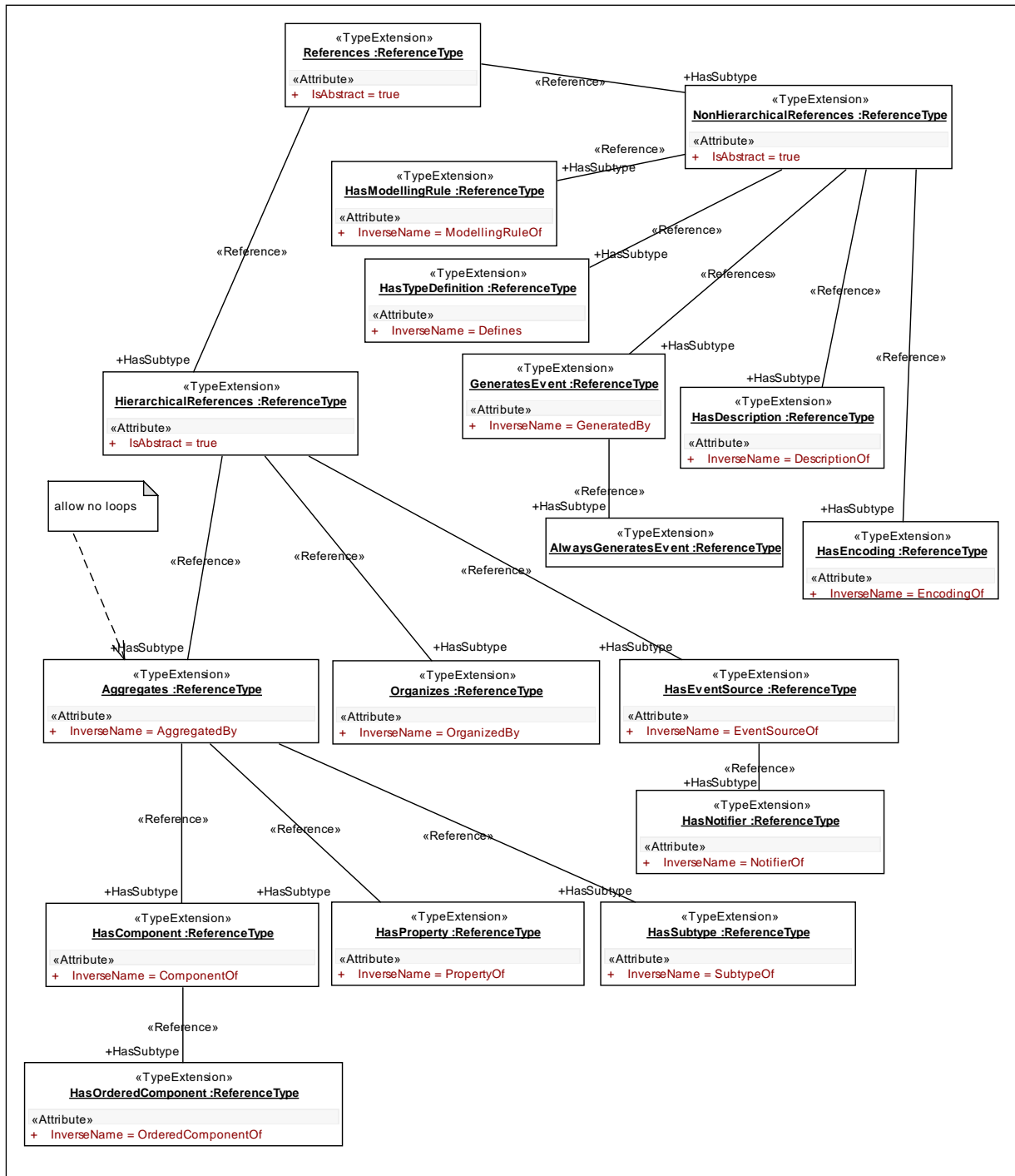

Figure B.6 – Predefined ReferenceTypes

### B.3.4 Attributes

Attributes are shown in Figure B.7.

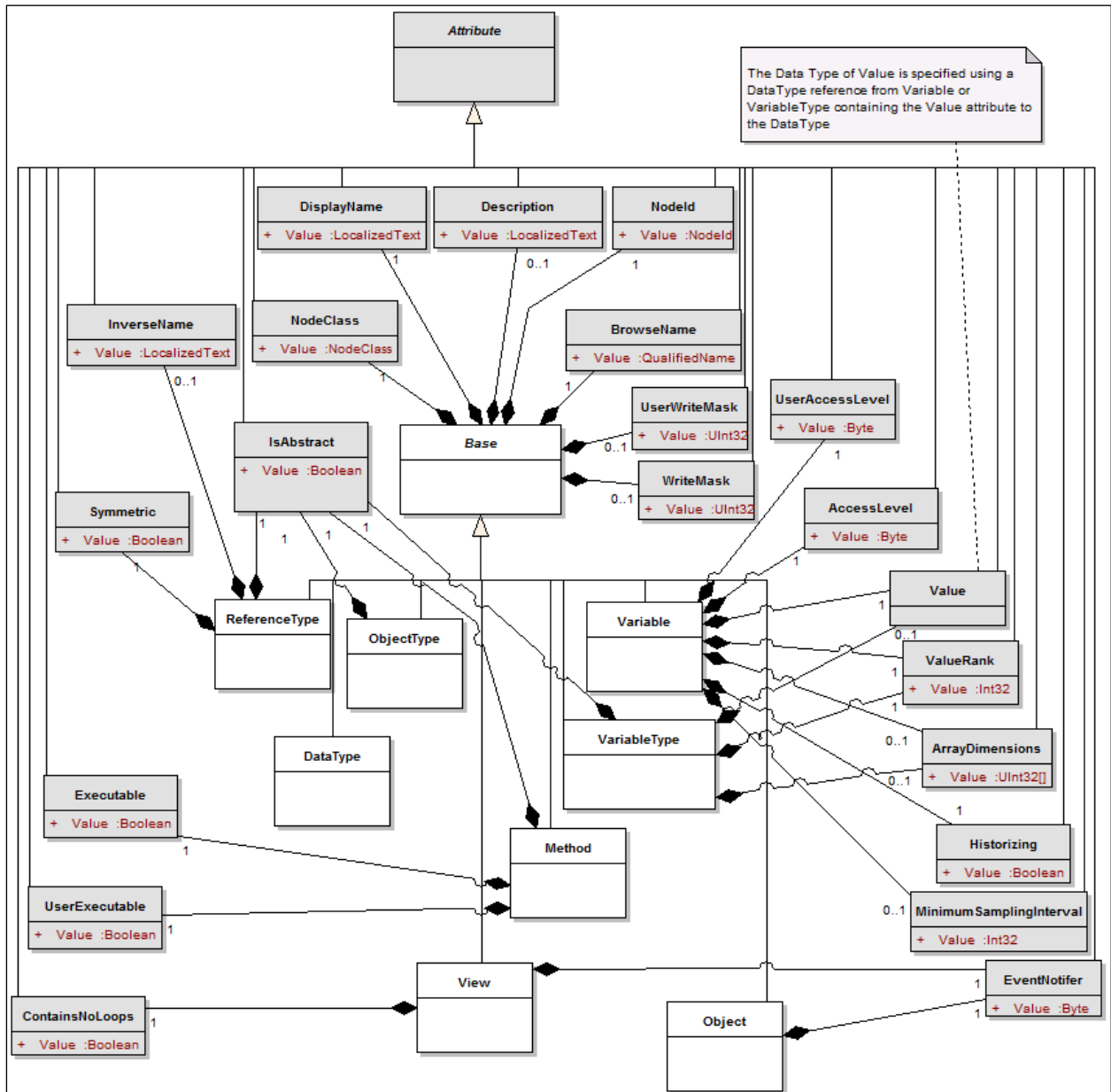

Figure B.7 – Attributes

There may be more *Attributes* defined in other parts of this series of standards.

*Attributes* used for references, which have a *NodeId* as *DataType*, are not shown in this diagram but are shown as stereotyped associations in the other diagrams.

### B.3.5 Object and ObjectType

*Objects* and *ObjectTypes* are shown in Figure B.8.

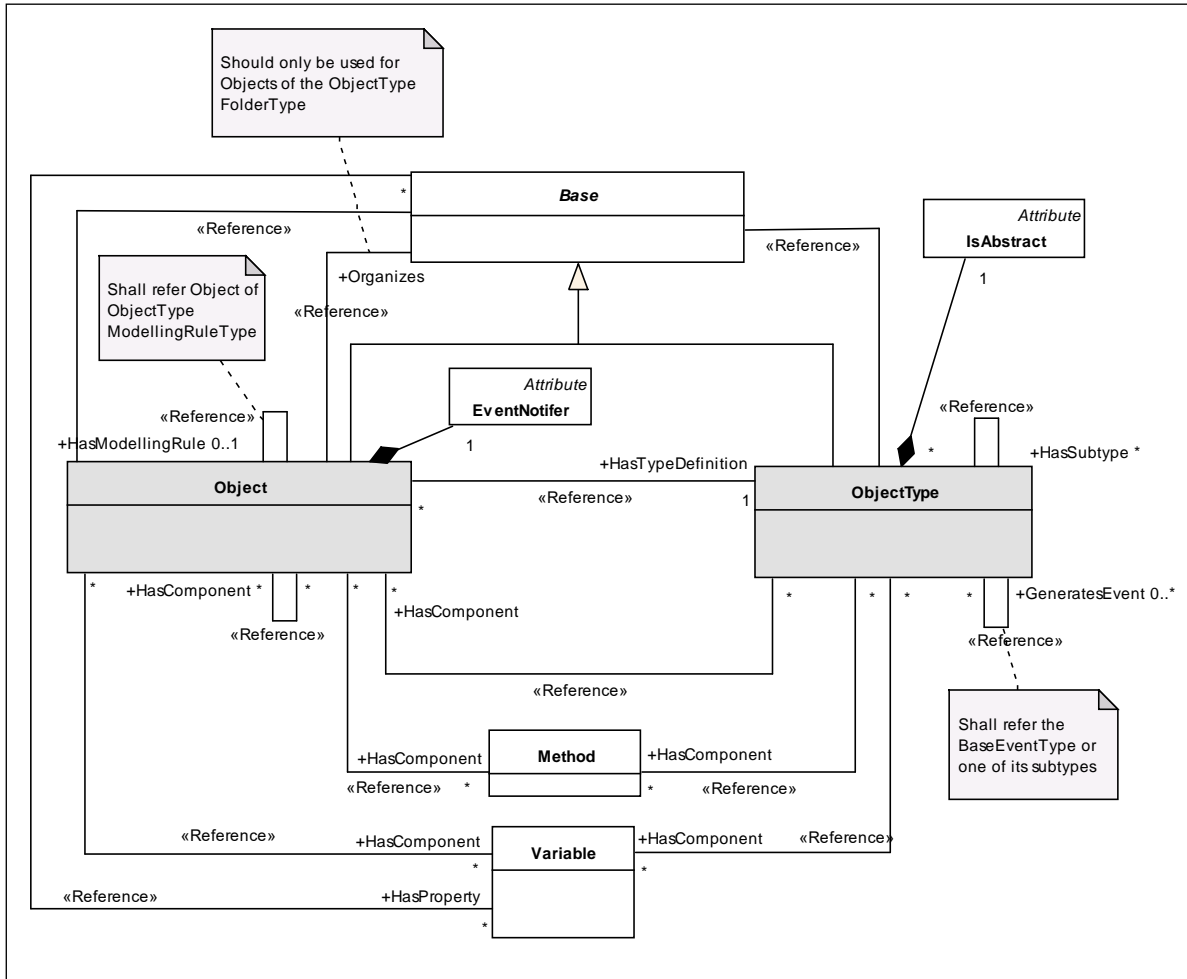

Figure B.8 – Object and ObjectType

**B.3.6 EventNotifier**

EventNotifier are shown in Figure B.9.

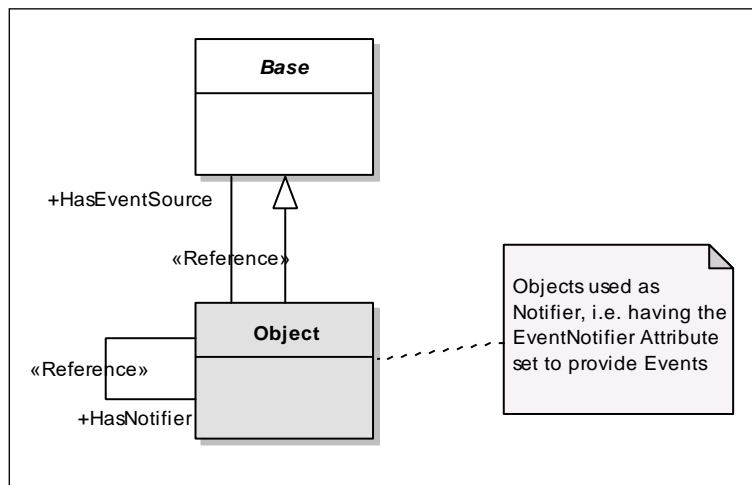
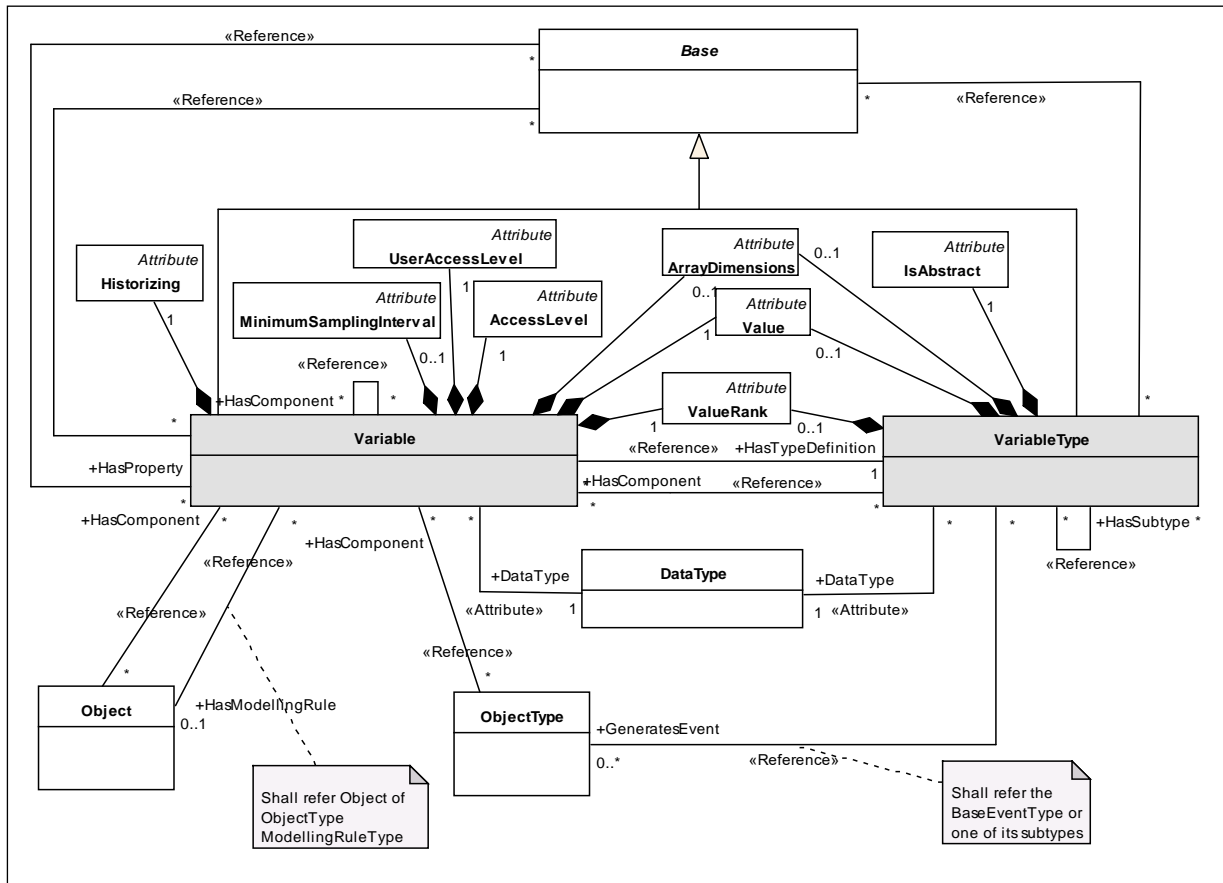

Figure B.9 – EventNotifier

**B.3.7 Variable and VariableType**

Variable and VariableType are shown in Figure B.10.



**Figure B.10 – Variable and VariableType**

The *DataType* of a *Variable* shall be the same as or a subtype of the *DataType* of its *VariableType* (referred with *HasTypeDefinition*).

If a *HasProperty* points to a *Variable* from a *Base* “A” then the following constraints apply:

- The *Variable* shall not be the *SourceNode* of a *HasProperty* or any other *HierarchicalReferences* Reference.
- All *Variables* having “A” as the *SourceNode* of a *HasProperty* Reference shall have a unique *BrowseName* in the context of “A”.

### B.3.8 Method

Method is shown in Figure B.11

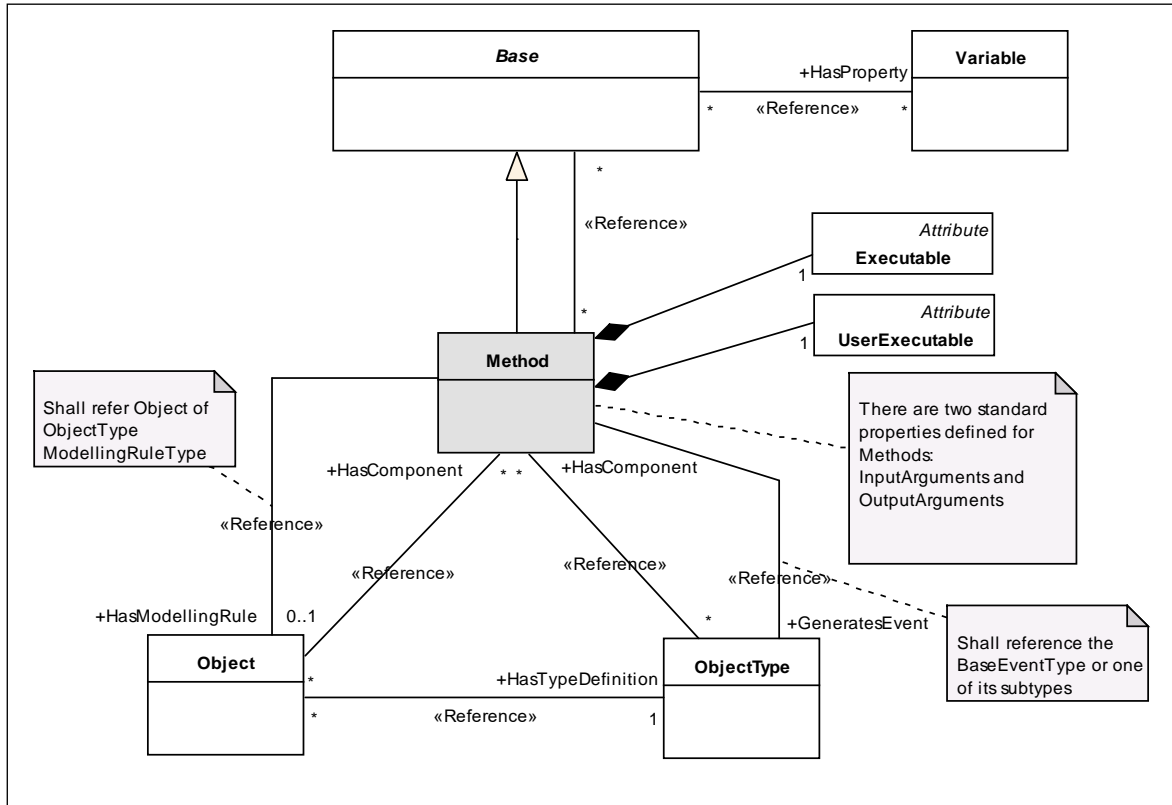

Figure B.11 – Method

### B.3.9 DataType

DataType is shown in Figure B.12.

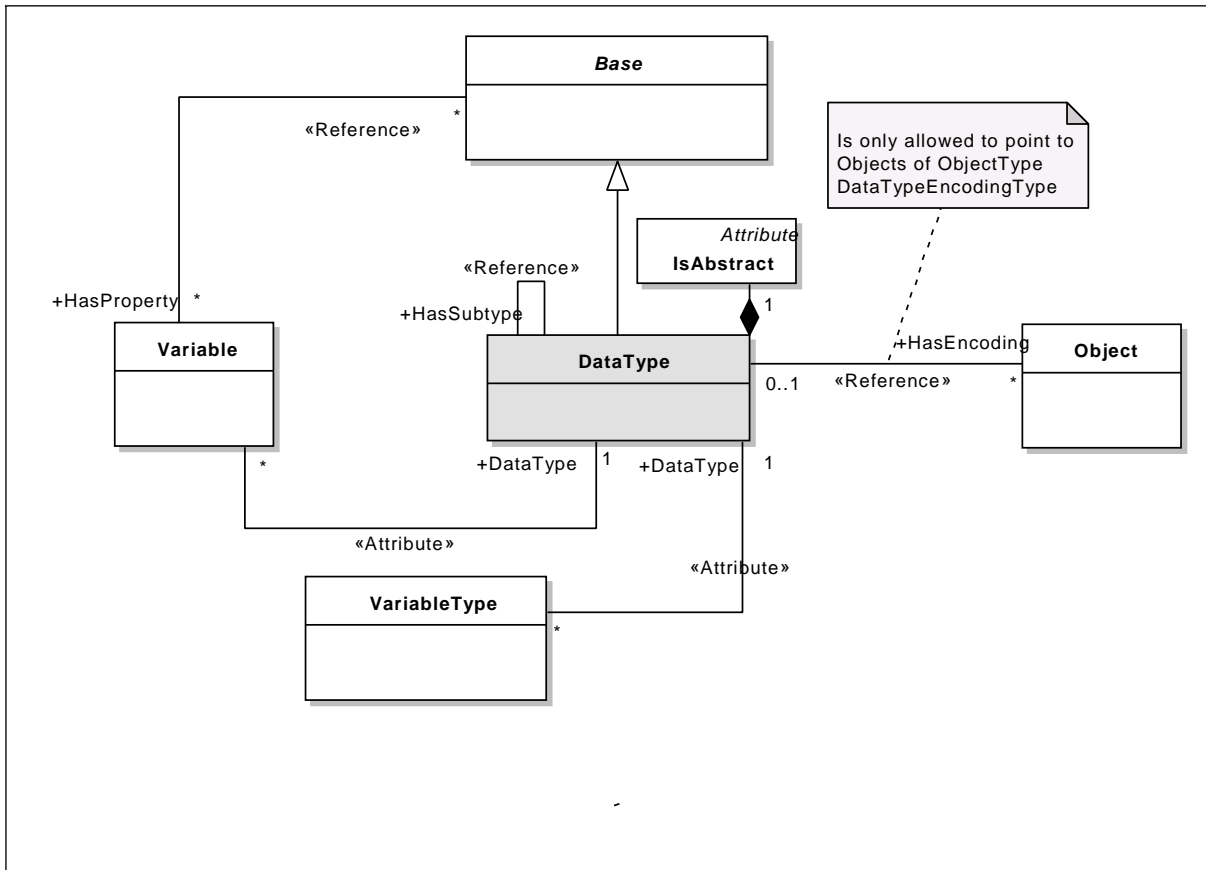

Figure B.12 – DataType

**B.3.10 View**

View is shown in Figure B.13.

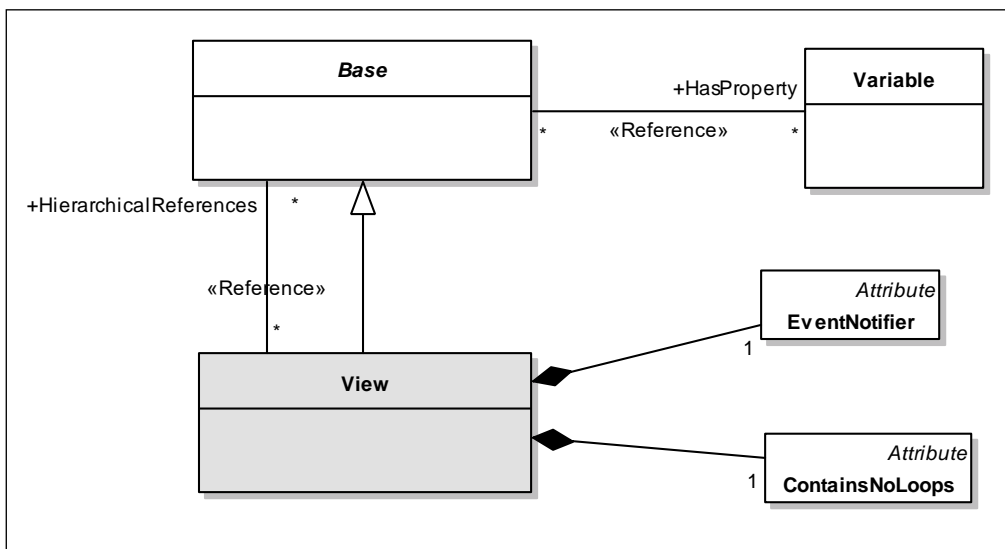

Figure B.13 – View

## **Annex C** (normative)

### **Graphical Notation**

#### **C.1 General**

Annex D defines a graphical notation for OPC UA data. Annex D is normative, that is, the notation is used in this standard to expose examples of OPC UA data. However, it is not required to use this notation to expose OPC UA data.

The graphical notation is able to expose all structural data of OPC UA. *Nodes*, their *Attributes* including their current value and *References* between the *Nodes* including the *ReferenceType* can be exposed. The graphical notation provides no mechanism to expose events or historical data.

#### **C.2 Notation**

##### **C.2.1 Overview**







The notation is divided into two parts. The simple notation only provides a simplified view on the data hiding some details like *Attributes*. The extended notation allows exposing all structure information of OPC UA, including *Attribute* values. The simple and the extended notation can be combined to expose OPC UA data in one figure.

Common to both notations is that neither any colour nor the thickness or style of lines is relevant for the notation. Those effects can be used to highlight certain aspects of a figure.

##### **C.2.2 Simple Notation**

Depending on their *NodeClass* *Nodes* are represented by different graphical forms as defined in Table C.1.

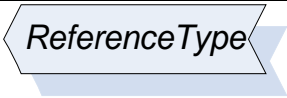
**Table C.1 – Notation of Nodes depending on the NodeClass**

NodeClass	Graphical Representation	Comment
Object		Rectangle including text representing the string-part of the <i>DisplayName</i> of the <i>Object</i> . The font shall not be set to italic.
ObjectType		Shadowed rectangle including text representing the string-part of the <i>DisplayName</i> of the <i>ObjectType</i> . The font shall be set in italic.
Variable		Rectangle with rounded corners including text representing the string-part of the <i>DisplayName</i> of the <i>Variable</i> . The font shall not be set in italic.
VariableType		Shadowed rectangle with rounded corners including text representing the string-part of the <i>DisplayName</i> of the <i>VariableType</i> . The font shall be set in italic.
DataType		Shadowed hexagon including text representing the string-part of the <i>DisplayName</i> of the <i>DataType</i> .
ReferenceType		Shadowed six-sided polygon including text representing the string-part of the <i>DisplayName</i> of the <i>ReferenceType</i> .
Method		Oval including text representing the string-part of the <i>DisplayName</i> of the <i>Method</i> .
View		Trapezium including text representing the string-part of the <i>DisplayName</i> of the <i>View</i> .

*References* are represented as lines between *Nodes* as exemplified in Figure C.1. Those lines can vary in their form. They do not have to connect the *Nodes* with a straight line; they can have angles, arches, etc.

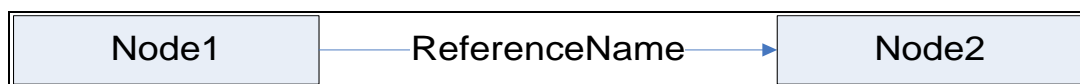
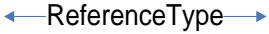
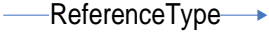
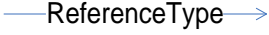





**Figure C.1 – Example of a Reference connecting two Nodes**

Table C.2 defines how symmetric and asymmetric *References* are represented in general, and also defines shortcuts for some *ReferenceTypes*. Although it is recommended to use those shortcuts, it is not required. Thus, instead of using the shortcut, the generic solution can also be used.



**Table C.2 – Simple Notation of Nodes depending on the NodeClass**

ReferenceType	Graphical Representation	Comment
Any symmetric ReferenceType		Symmetric <i>ReferenceTypes</i> are represented as lines between <i>Nodes</i> with closed and filled arrows on both sides pointing to the connected <i>Nodes</i> . Near the line has to be a text containing the string-part of the <i>BrowseName</i> of the <i>ReferenceType</i> .
Any asymmetric ReferenceType		Asymmetric <i>ReferenceTypes</i> are represented as lines between <i>Nodes</i> with a closed and filled arrow on the side pointing to the <i>TargetNode</i> . Near the line has to be a text containing the string-part of the <i>BrowseName</i> of the <i>ReferenceType</i> .
Any hierarchical ReferenceType		Asymmetric <i>ReferenceTypes</i> that are subtypes of <i>HierarchicalReferences</i> should be exposed the same way as asymmetric <i>ReferenceTypes</i> except that an open arrow is used.
HasComponent		The notation provides a shortcut for <i>HasComponent References</i> shown on the left. The single hashed line has to be near the <i>TargetNode</i> .
HasProperty		The notation provides a shortcut for <i>HasProperty References</i> shown on the left. The double hashed lines have to be near the <i>TargetNode</i> .
HasTypeDefinition		The notation provides a shortcut for <i>HasTypeDefinition References</i> shown on the left. The double closed and filled arrows have to point to the <i>TargetNode</i> .
HasSubtype		The notation provides a shortcut for <i>HasSubtype References</i> shown on the left. The double closed arrows have to point to the <i>SourceNode</i> .
HasEventSource		The notation provides a shortcut for <i>HasEventSource References</i> shown on the left. The closed arrow has to point to the <i>TargetNode</i> .

### C.2.3 Extended Notation

In the extended notation some additional concepts are introduced. It is allowed only to use some of those concepts on elements of a figure.

The following rules define some special handling of structures.

- In general, values of all *DataTypes* should be represented by an appropriate string representation. Whenever a *NamespaceIndex* or *LocaleId* is used in those structures they can be omitted.
- The *DisplayName* contains a *LocaleId* and a *String*. Such a structure can be exposed as [*<LocaleId>*]:*<String>* where the *LocaleId* is optional. For example, a *DisplayName* can be “en:MyName”. Instead of that, “MyName” can also be used. This rule applies whenever a *DisplayName* is shown, including the text used in the graphical representation of a *Node*.
- The *BrowseName* contains the *NamespaceIndex* and a *String*. Such a structure can be exposed as [*<NamespaceIndex>*]:*<String>* where the *NamespaceIndex* is optional. For example, a *BrowseName* can be “1:MyName”. Instead of that, “MyName” can also be used. This rule applies whenever a *BrowseName* is shown, including the text used in the graphical representation of a *Node*.

Instead of using the *HasTypeDefinition* reference to point from an *Object* or *Variable* to its *ObjectType* or *VariableType* the name of the *TypeDefinition* can be added to the text used in the *Node*. The *TypeDefinition* shall either be prefixed with “:.” or it is put in italic as the top line. Figure C.2 gives an example, where “Node1” uses a *Reference* and “Node2” the shortcut in both notation variants. A figure can contain *HasTypeDefinition References* for some *Nodes* and the shortcut for other *Nodes*. It is not allowed that a *Node* uses the shortcut and additionally is the *SourceNode* of a *HasTypeDefinition*.

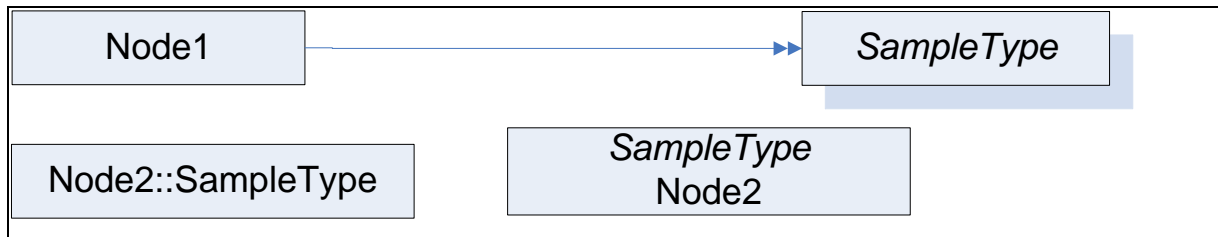

**Figure C.2 – Example of using a TypeDefinition inside a Node**

To display *Attributes* of a *Node* additional text can be put inside the form representing the *Node* under the text representing the *DisplayName*. The *DisplayName* and the text describing the *Attributes* have to be separated using a horizontal line. Each *Attribute* has to be set into a new text line. Each text line shall contain the *Attribute* name followed by an “=” and the value of the *Attribute*. On top of the first text line containing an *Attribute* shall be a text line containing the underlined text “Attribute”. It is not required to expose all *Attributes* of a *Node*. It is allowed to show only a subset of *Attributes*. If an optional *Attribute* is not provided, the *Attribute* can be marked by a strike-through line, for example “~~Description~~”. Examples of exposing *Attributes* are shown in Figure C.3.

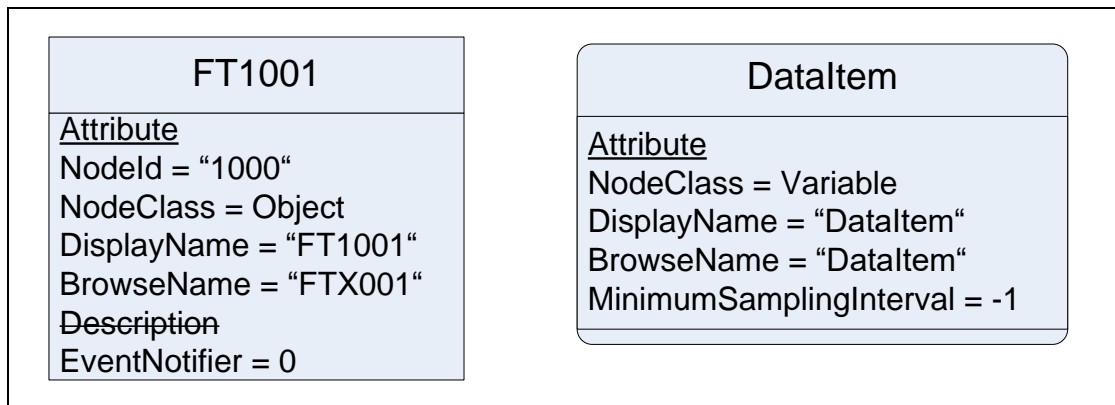

**Figure C.3 – Example of exposing Attributes**

To avoid too many *Nodes* in a figure it is allowed to expose *Properties* inside a *Node*, similar to *Attributes*. Therefore, the text field used for exposing *Attributes* is extended. Under the last text line containing an *Attribute* a new text line containing the underlined text “Property” has to be added. If no *Attribute* is provided, the text has to start with this text line. After this text line, each new text line shall contain a *Property*, starting with the *BrowseName* of the *Property* followed by “=” and the value of the *Value Attribute* of the *Property*. Figure C.4 shows some examples exposing *Properties* inline. It is allowed to expose some *Properties* of a *Node* inline, and other *Properties* as *Nodes*. It is not allowed to show a *Property* inline as well as an additional *Node*.

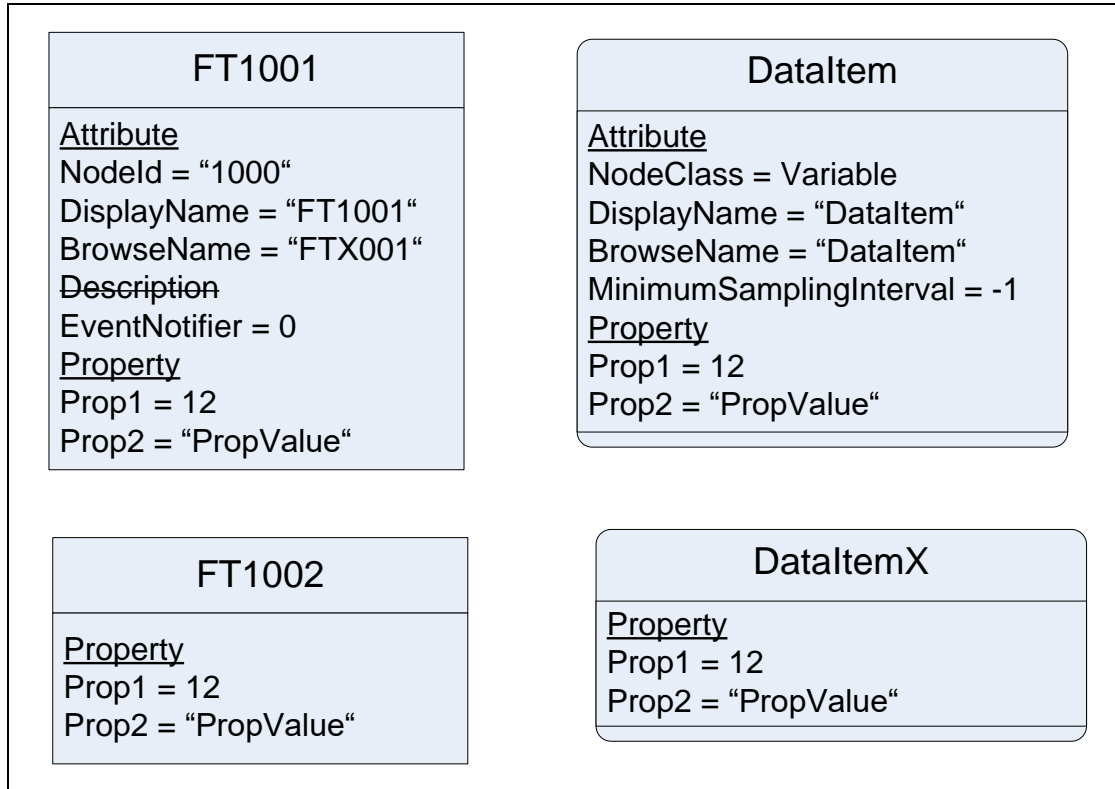

**Figure C.4 – Example of exposing Properties inline**

It is allowed to add additional information to a figure using the graphical representation, for example callouts.